

USL SERIES

0.4mm PITCH CONNECTOR FOR MICRO COAXIAL CABLE

RoHS
Compliant

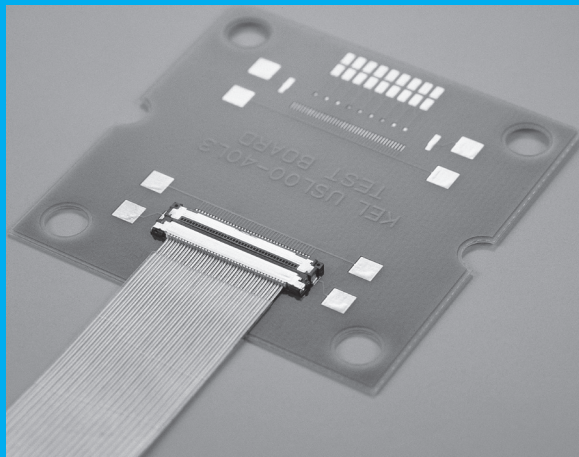

FEATURES

- ▶ Compact connector with a low profile of 1.0 mm(0.039") and a mating width of 5.6 mm(0.220").
- ▶ For micro coaxial cable(#42 AWG).
- ▶ IDC of contacts all together is adopted for improved connection reliability and more compact connectors.
- ▶ Equipped with a metal shell, noise reduction and product strength are ensured.
- ▶ Multiple ground terminals are provided for enhanced transmission characteristics and EMS protection.
- ▶ Highly reliable design with effective mating length of 0.5mm(0.020).

*Specially designed withdrawal jig is available.

ORDER CODE

USL00- **L**-

① ② ③ ④

*Please order in multiples of the quantity per package.

- ① **[Type]** USL00 : Receptacle (PCB side connector)
- ② **[Number of contacts]** 20 : 20 pin 30 : 30 pin 40 : 40 pin
- ③ **[Contact tail style]** L : Right angle
- ④ **[Number of packaging]** A : 500pcs. per reel B : 1,000pcs. per reel C : 3,000pcs. per reel

ORDER CODE

USL20- **S**

① ② ③

*Please order in multiples of the quantity per package.

- ① **[Type]** USL20 : Plug (Cable side connector)
- ② **[Number of contacts]** 20 : 20 pin 30 : 30 pin 40 : 40 pin
- ③ **[Cable exit style]** S : Straight

*Plug (cable side connector) is composed of base and cover.

SPECIFICATIONS

Material and plating		Electrical characteristics	
Insulator material	Glass-filled LCP(UL94V-0),Black	Rated current	0.25A per contact
Contact material	Copper alloy	Contact resistance	100mΩ max.
Contact plating	Gold over Nickel	Dielectric withstanding voltage	200V AC for 1minute
Shell material	Copper alloy	Insulation resistance	100MΩ min.at 250V DC
Shell plating	Tin copper over Nickel	Operating temperature	-40°C to +85°C
IDC cover material	[USL20] Glass-filled LCP(UL94V-0),White	Applicable cable	#42 AWG Micro coaxial cables

Mating drawing

Unit : mm(inch)

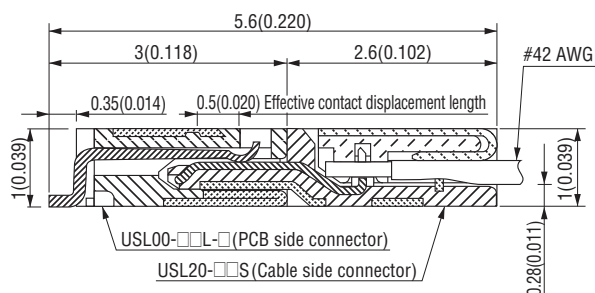

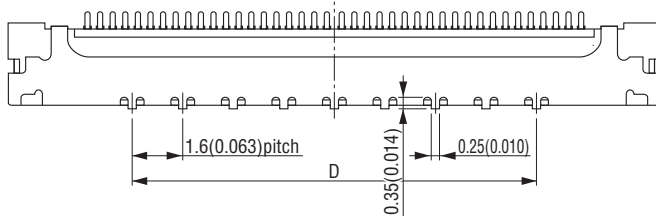
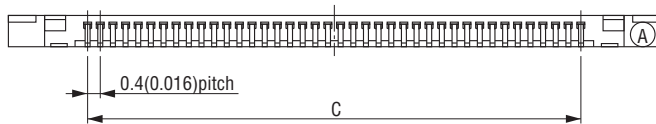
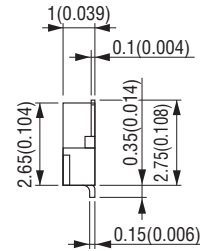
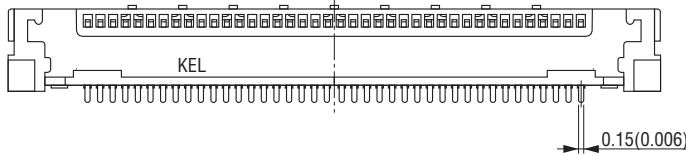
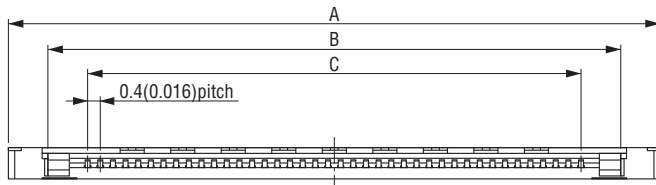
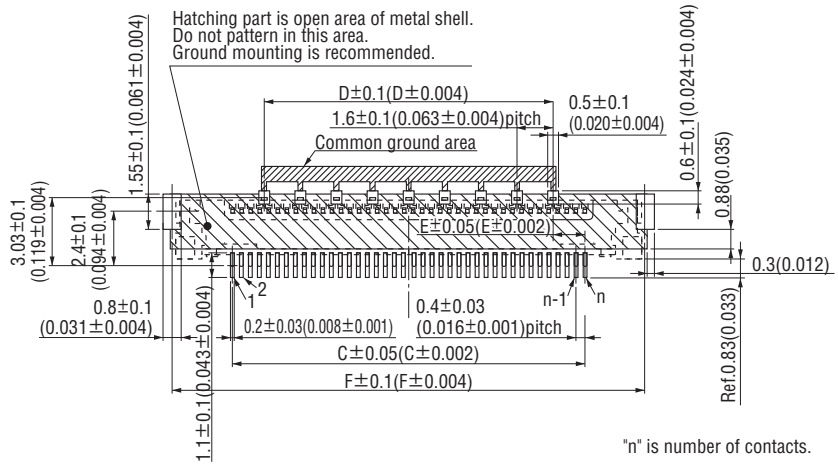
Printed Circuit Board layout (Component side view)

Packaging style
Embossed tape

Product table

Part number	Number of packaging
USL00-□□L-A	500
USL00-□□L-B	1,000
USL00-□□L-C	3,000

Product table / Dimensions

No. of contacts	Part number	A	B	C	D	E	F
20	USL00-20L-□	12.6 (0.496)	10.1 (0.398)	7.6 (0.299)	6.4 (0.252)	0.6 (0.024)	12.8 (0.504)
30	USL00-30L-□	16.6 (0.654)	14.1 (0.555)	11.6 (0.457)	9.6 (0.378)	1.0 (0.039)	16.8 (0.661)
40	USL00-40L-□	20.6 (0.811)	18.1 (0.713)	15.6 (0.614)	12.8 (0.504)	1.4 (0.055)	20.8 (0.819)

USL20-□□S (Plug, Cable side connector)

Unit : mm(inch)

USL20-□□S Base

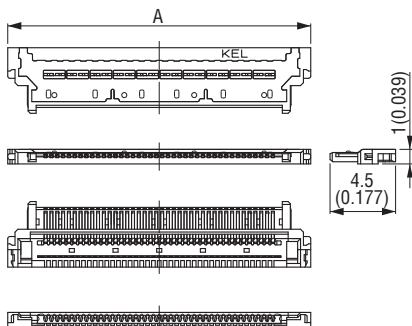

USL20-□□CV

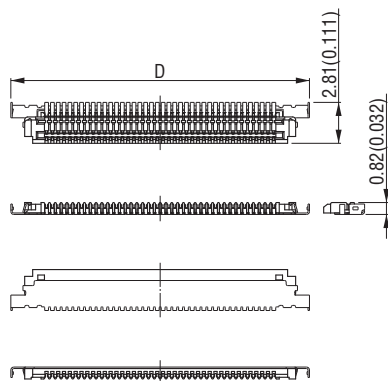

*USL20-□□SBase and USL20-□□CV are component parts of USL20-□□S.

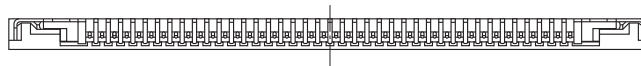
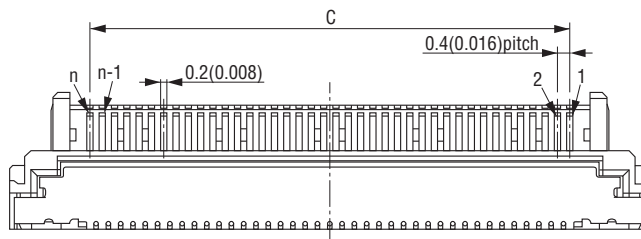
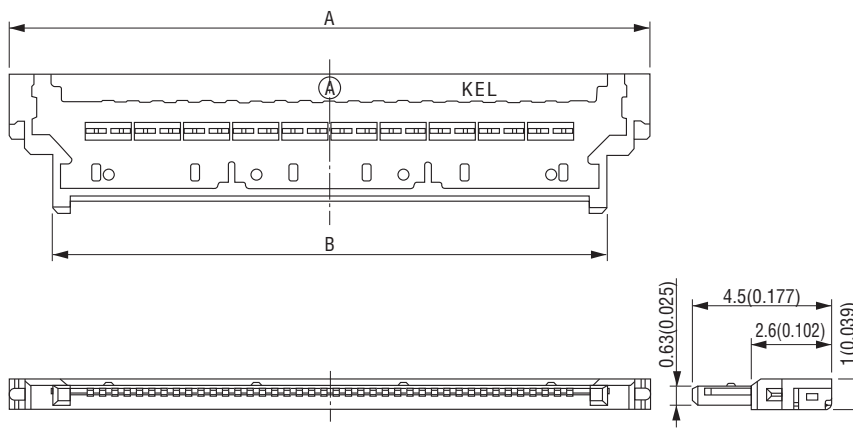

"n" is number of contacts.

Packaging style

Other

Product table / Dimensions

No. of contacts	Part number	A	B	C	D	Number of packaging
20	USL20-20S	12.8 (0.504)	10.1 (0.398)	7.6 (0.299)	12.5 (0.492)	2,000
30	USL20-30S	16.8 (0.661)	14.1 (0.555)	11.6 (0.457)	16.5 (0.650)	2,000
40	USL20-40S	20.8 (0.819)	18.1 (0.713)	15.6 (0.614)	20.5 (0.807)	2,000

CABLE ASSEMBLY

ORDER CODE

USL20- **SS-**

① ② ③ ④ ⑤ ⑥ ⑦ ⑧ ⑨

- | | |
|--|--|
| ① [Type] USL20 : Plug (Cable side connector) | ⑥ [Wiring code] B : Pin 1 to Pin 1 C : Pin 1 to Pin n |
| ② [Number of contacts] 20 : 20 pin 30 : 30 pin 40 : 40 pin | ⑦ [Laminated tape] No code : Without tape H : With tape |
| ③ [Cable exit style(Left side, CN1)] S : Straight | ⑧ [Quantity] (B) : 10 to 49pcs (C) : 50 to 99pcs (D) : 100pcs or more |
| ④ [Cable exit style(Right side, CN2)] S : Straight | ⑨ [Cable classification] S : Standard *2 |
| ⑤ [Cable length (cm)] L : dimension (Example : 013.5=13.5cm) *1 | |

*1.Applicable cable length : 4 to 100cm Minimum cable length for USL20-□□SS-□□□□-□-□-□-□ : 7cm
*2.If you have a specified cable, please contact your local KEL sales office.

► Cable assembly style

Wiring code :
Pin 1 to Pin 1

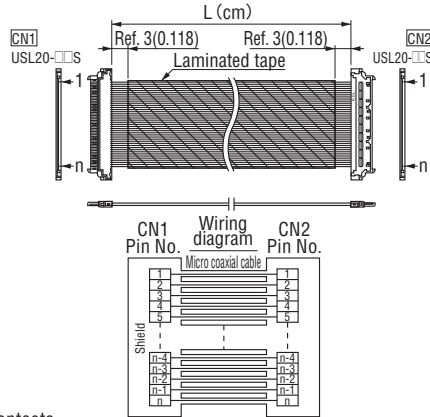

* "n" is number of contacts.

Unit : mm (inch)

Wiring code :
Pin 1 to Pin n

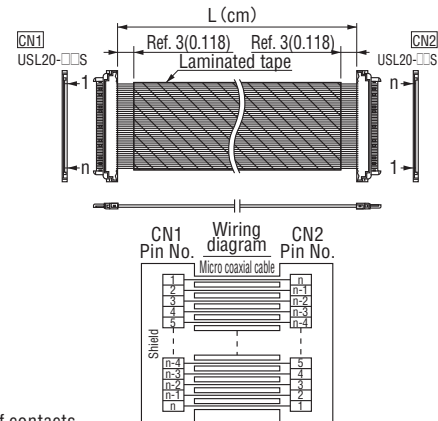

* "n" is number of contacts.

*Please contact your local KEL sales office for inquiries regarding cable length and tolerance.

*Laminated tape is designed to be a little wider than the cable width. Please contact your local KEL sales office for further details.

ORDER CODE

USL+S20- -

① ② ③ ④ ⑤ ⑥ ⑦

- | |
|--|
| ① [Type] USL+S 20 : Plug (Cable side connector) Left side connector, CN1 / USL20 series Right side connector, CN2 / USLS20 series |
| ② [Number of contacts] 20 : 20 pin 30 : 30 pin 40 : 40 pin |
| ③ [Cable length (cm)] L : Dimension(Example : 013.5=13.5cm) *1 |
| ④ [Wiring code] B : Pin 1 to Pin 1 C : Pin 1 to Pin n |
| ⑤ [Laminated tape] No code : Without tape H : With tape |
| ⑥ [Quantity] (B) : 10 to 49pcs (C) : 50 to 99pcs (D) : 100pcs or more |
| ⑦ [Cable classification] S : Standard *2 |

*1.Applicable cable length : 4 to 100cm Minimum cable length for USL+S20-□□-□□□□-□-□-□-□ : 7cm
*2.If you have a specified cable, please contact your local KEL sales office.

► Cable assembly style

Wiring code :
Pin 1 to Pin 1

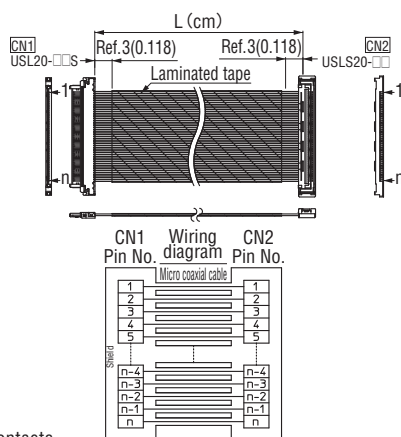

* "n" is number of contacts.

Unit : mm (inch)

Wiring code :
Pin 1 to Pin n

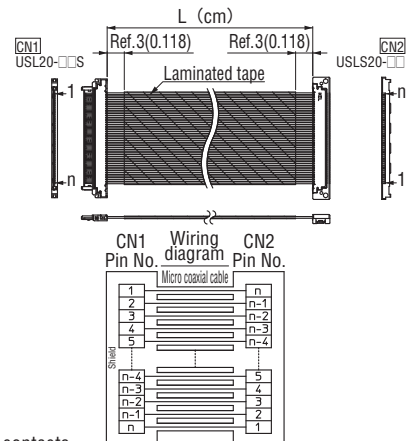

* "n" is number of contacts.

*Please contact your local KEL sales office for inquiries regarding cable length and tolerance.

*Laminated tape is designed to be a little wider than the cable width. Please contact your local KEL sales office for further details.