

# FTCS SERIES

## 2.5mm PITCH CONNECTOR FOR DISCRETE CABLE / TWO CABLES CRIMPABLE TYPE

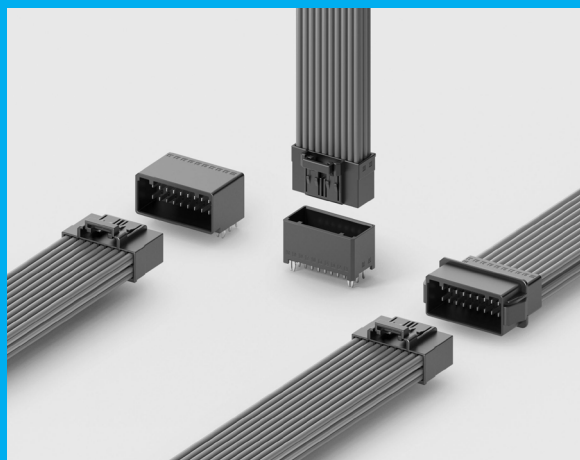

### FEATURES

- ▶ This connector allows two cables to be crimped into one contact.
- ▶ The crimped contact of the cable can be mounted anywhere on the housing.
- ▶ By crimping two cables, space is saved and power supply can be transferred between the connectors.
- ▶ Twin-Leaf Pinching 2 point contact structure prevents contact buckling and improves reliability with stable contact force.
- ▶ The receptacle side connector has lock type (FTCS02). The plug side connector has straight type (FTCS11) and right angle type (FTCS11) and cable relay type (FTC12).
- ▶ FTCS has the same features as FTC, and has been made smaller to 2.5mm pitch.
- ▶ The FTCS panel mounting structure allows it to be fixed in any position.

### ORDER CODE

**FTCS02** -   
 ①                      ②

\*Please order in multiples of the quantity per package.

- ① **[Type] FTCS02** : Receptacle (Cable side connector) with lock type
- ② **[Number of contacts]** 06 : 6 pin   12 : 12 pin   16 : 16 pin   20 : 20 pin

\*FTCS02-□□ is sold only as a housing and contacts are sold separately. Please check the "Crimp contact" page for contact order codes.

### ORDER CODE

**FTCS11** -   
 ①                      ②                      ③                      ④

\*Please order in multiples of the quantity per package.

- ① **[Type] FTCS11** : Plug (PCB side connector)
- ② **[Number of contacts]** (S type) 06 : 6 pin   12 : 12 pin   20 : 20 pin  
 (L type) 06 : 6 pin   12 : 12 pin   16 : 16 pin   20 : 20 pin
- ③ **[Contact tail style]** S : Straight   L : Right angle
- ④ **[Gold plating thickness]** B : 0.1μm min.   F : 0.38μm min

### ORDER CODE

**FTCS12** -  **P**  
 ①                      ②                      ③

\*Please order in multiples of the quantity per package.

- ① **[Type] FTCS12** : Plug (Cable-relay type)
- ② **[Number of contacts]** 06 : 6 pin   12 : 12 pin   20 : 20 pin
- ③ **[Style] P** : Panel mount type

\*FTCS12-□□P is sold only as a housing and contacts are sold separately. Please check the "Crimp contact" page for contact order codes.

### SPECIFICATIONS

Material and plating		Electrical characteristics	
Insulator material	Glass-filled PBT(UL94V-0), Black	Rated current	Refer the next page "Rated current table"
Contact material	Copper alloy	Rated voltage	250V AC-DC
Contact plating	[FTCS02/12] (Contact area) Gold over Nickel (Crimp area) Nickel over Nickel [FTCS11] (Contact area) Gold over Nickel (Terminal area) Gold over Nickel	Contact resistance	10mΩ max.
		Dielectric withstanding voltage	1,500V AC for 1 minute.
		Insulation resistance	1,000MΩ min. at 500V DC
		Operating temperature	-55°C to +105°C
		Durability of insertion and withdrawal	[Gold plating thickness 0.1μm min.] 100 times [Gold plating thickness 0.38μm min.] 500 times
Retention clip material	Copper alloy	Applicable cable	#18/20/22/24/26/28 AWG Discrete wire cables (Outer diameter of cable coating:φ0.88 to φ2.03mm)
Retention clip plating	Gold over Nickel	Tensile strength of crimped part	[AWG#18]120N min.   [AWG#20]75N min. [AWG#22]40N min.   [AWG#24]30N min. [AWG#26]15N min.   [AWG#28]8N min.

### Rated current table

► Standard Rated current

Unit: A (per contact)

Mating matrix			Cable size					
Receptacle	Plug	Number of contacts	AWG#18	AWG#20	AWG#22	AWG#24	AWG#26	AWG#28
FTCS02-□□	FTCS11-□□S□	6	8.5	7.5	7.0	6.5	6.0	4.5
		12	7.0	6.5	5.5	4.5	4.0	3.5
		20	6.0	5.5	5.0	4.0	3.5	2.5
	FTCS11-□□L□	6	8.0	7.0	6.5	6.0	5.5	4.5
		12	6.5	6.0	5.5	4.5	4.0	3.5
		16	6.0	5.5	5.0	4.5	4.0	3.0
		20	5.5	5.0	4.5	4.0	3.5	2.5
	FTCS12-□□P	6	8.5	7.5	6.5	5.5	4.5	4.0
		12	7.0	6.5	5.5	4.5	3.5	3.0
20		6.5	5.5	4.5	3.5	2.5	2.0	

► Rated current for UL UL1977 \*UL cUL File No. E509060

Unit: A (per contact)

Mating matrix		Cable size					
Receptacle	Plug	AWG#18	AWG#20	AWG#22	AWG#24	AWG#26	AWG#28
FTCS02-□□	FTCS11-□□S□	5.0	5.0	3.5	3.5	2.0	2.0
	FTCS11-□□L□	5.0	5.0	3.5	3.5	2.0	2.0
	FTCS12-□□P	5.0	5.0	3.5	3.5	2.0	2.0

### Mating table

ORDER CODE		Receptacle
		FTCS02-□□
Plug	FTCS11-□□S□	Vertical mating / With lock 6/12/20pin
	FTCS11-□□L□	Horizontal mating / With lock 6/12/16/20pin
	FTCS12-□□P	Cable-relay mating / With lock 6/12/20pin

### Contact number table

Product type		Number of contacts			
		6	12	16	20
Receptacle	FTCS02-□□ Cable side connector / With lock	√	√	√	√
	FTCS11-□□S□ PCB side connector / Straight	√	√	—	√
Plug	FTCS11-□□L□ PCB side connector / Right angle	√	√	√	√
	FTCS12-□□P Cable-relay type / Panel mount	√	√	—	√

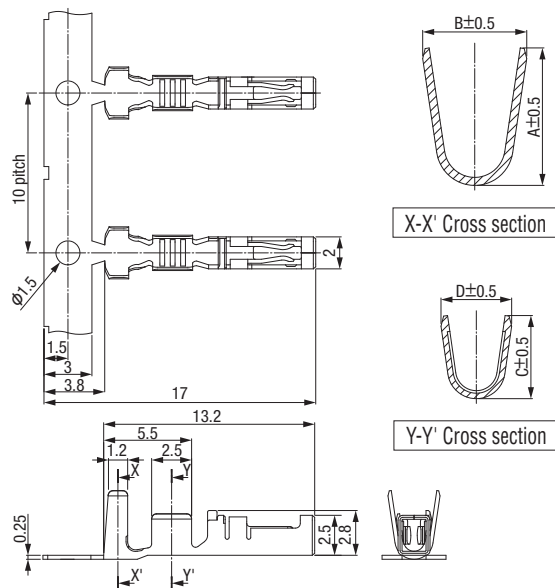
**◆ Crimp contact for FTCS02-□□ (Cable side connector) [Applicable cable size: S/M]**

**ORDER CODE**
**#674** - **□** - **□**  
 ① ② ③

\*Please order in multiples of the quantity per package.

- ① **[Contact name]** #674 : Crimp contact for FTCS02
- ② **[Gold plating thickness]** B : 0.1μm min. F : 0.38μm min.
- ③ **[Applicable cable size]**
  - S:** Single crimp AWG#22/24/26/28 (Outer diameter of cable coating: φ 0.88 to 1.58mm)  
Two-piece crimp AWG#26 × 2 pieces (Outer diameter of cable coating: φ 0.98 to 1.3mm × 2 pieces)  
Two-piece crimp AWG#28 × 2 pieces (Outer diameter of cable coating: φ 0.88 to 1.2mm × 2 pieces)
  - M:** Single crimp AWG#18/20/22 (Outer diameter of cable coating: φ 1.58 to 2.03mm)  
Two-piece crimp AWG#20 × 2 pieces (Outer diameter of cable coating: φ 1.58 to 1.87mm × 2 pieces)  
Two-piece crimp AWG#22 × 2 pieces (Outer diameter of cable coating: φ 1.30 to 1.68mm × 2 pieces)  
Two-piece crimp AWG#24 × 2 pieces (Outer diameter of cable coating: φ 1.12 to 1.43mm × 2 pieces)

**▶ Product table / Dimensions**

Part number	A	B	C	D	No. of packaging
#674□-S	3.6	2.80	1.8	1.59	4,000
#674□-M	4.3	3.26	2.6	2.21	4,000

Packaging style
Reel

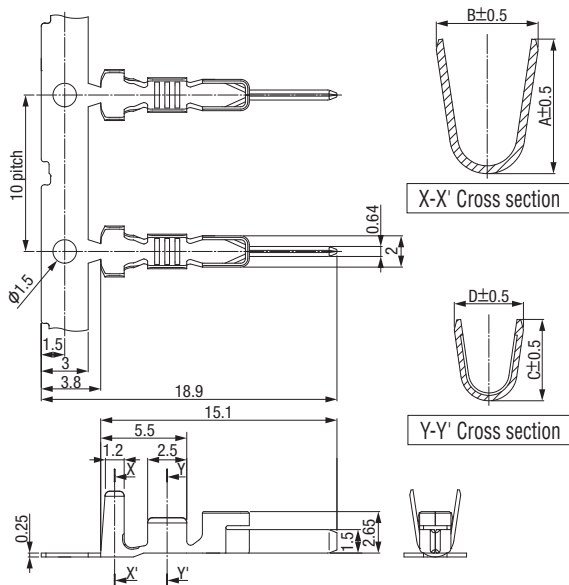
**◆ Crimp contact for FTCS12-□□P (Cable relay type) [Applicable cable size: S/M]**

**ORDER CODE**
**#677** - **□** - **□**  
 ① ② ③

\*Please order in multiples of the quantity per package.

- ① **[Contact name]** #677 : Crimp contact for FTCS12
- ② **[Gold plating thickness]** B : 0.1μm min. F : 0.38μm min.
- ③ **[Applicable cable size]**
  - S:** Single crimp AWG#22/24/26/28 (Outer diameter of cable coating: φ 0.88 to 1.58mm)  
Two-piece crimp AWG#26 × 2 pieces (Outer diameter of cable coating: φ 0.98 to 1.3mm × 2 pieces)  
Two-piece crimp AWG#28 × 2 pieces (Outer diameter of cable coating: φ 0.88 to 1.2mm × 2 pieces)
  - M:** Single crimp AWG#18/20/22 (Outer diameter of cable coating: φ 1.58 to 2.03mm)  
Two-piece crimp AWG#20 × 2 pieces (Outer diameter of cable coating: φ 1.58 to 1.87mm × 2 pieces)  
Two-piece crimp AWG#22 × 2 pieces (Outer diameter of cable coating: φ 1.30 to 1.68mm × 2 pieces)  
Two-piece crimp AWG#24 × 2 pieces (Outer diameter of cable coating: φ 1.12 to 1.43mm × 2 pieces)

**▶ Product table / Dimensions**

Part number	A	B	C	D	No. of packaging
#677□-S	3.6	2.80	1.8	1.59	4,000
#677□-M	4.3	3.26	2.6	2.21	4,000

Packaging style
Reel

**Twin-Leaf Pinching 2-point contact structure**

With the KEL original twin-leaf pinching 2-point contact structure, the flat plate type contact of plug connector is inserted into the contact of receptacle connector (A part of the figure on the right side) for electrical contact.

The flat plate shaped contact of plug connector is tolerant of buckling compared to pin header type contact, and the stable contact force of the pinching structure of receptacle connector assures high reliability of electrical contact.

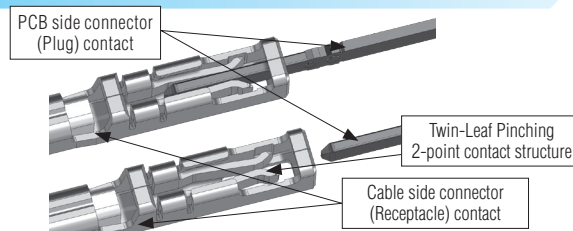
**Assembly Tool**
**◆ Crimping hand tool**

Part number	Crimp contact	Number of cables	Applicable cable size
CH-24	#674□-S #677□-S	1	AWG#22/24/26/28
CH-25	#674□-S #677□-S	2	AWG#26/28 × 2
CH-26	#674□-M #677□-M	1	AWG#18/20/22
CH-27	#674□-M #677□-M	2	AWG#20/22/24 × 2

**◆ Crimping machine**

Crimp contact	#674□-S	#677□-S	#674□-M	#677□-M
Manufacturer	Japan Automatic Machine Co., Ltd.			
Crimping machine	LPC220S			
Applicator	CFX105700K		CFX105800K	

\*A crimping machine and applicator can be purchased from Japan Automatic Machine Co., Ltd.

# FTCS02-□□ (Receptacle, Cable side connector, With lock)

Unit : mm

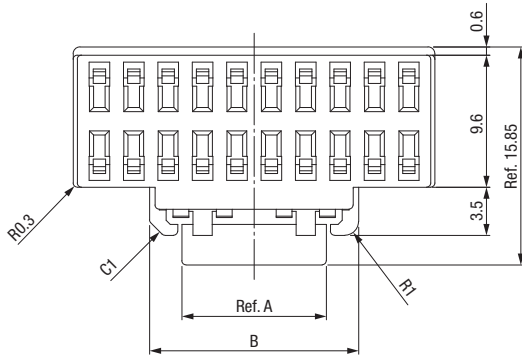

**X-X' Cross section  
(With the contact inserted)**

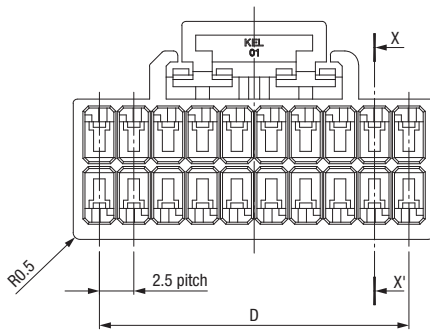
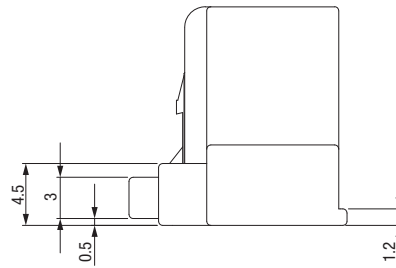
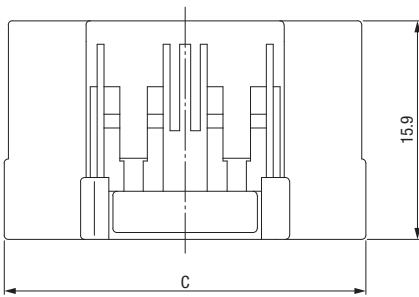
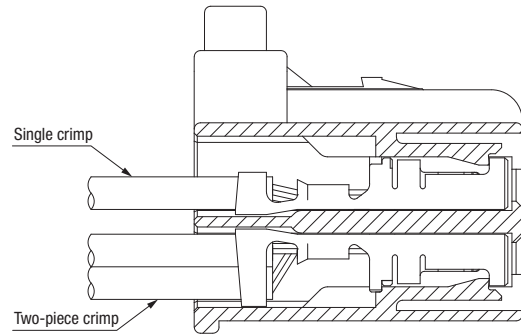

Packaging style  
Other

► **Product table / Dimensions**

No. of contacts	Part number	A	B	C	D	No. of packaging
6	FTCS02-06	3.0	7.7	8.8	5.0	400
12	FTCS02-12	10.5	15.2	16.3	12.5	300
16	FTCS02-16	10.5	15.2	21.3	17.5	200
20	FTCS02-20	10.5	15.2	26.3	22.5	200

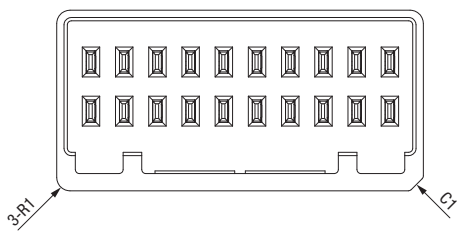
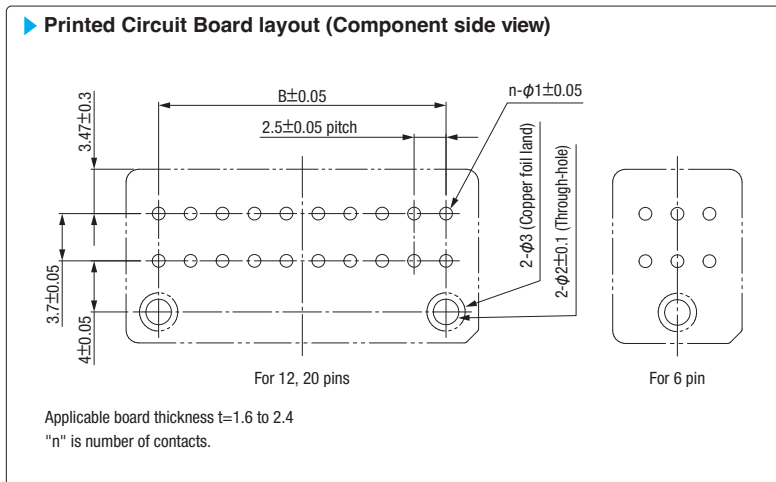
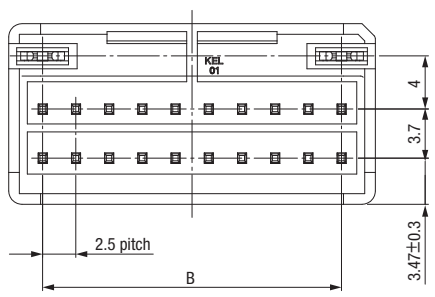
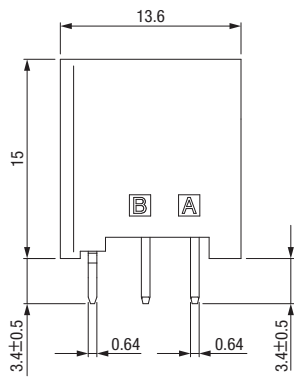
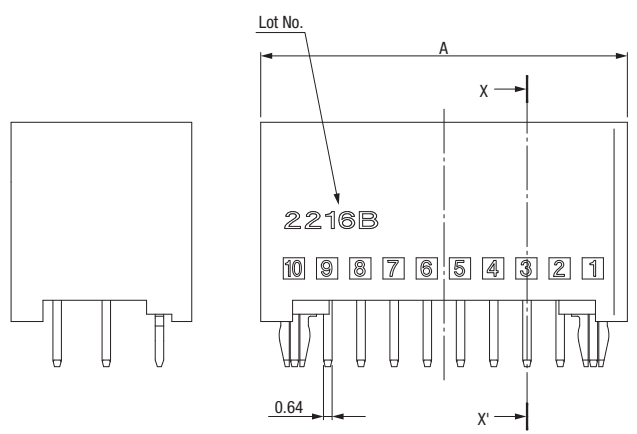
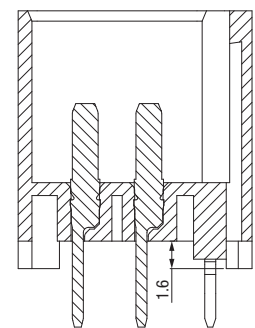
**X-X' Cross section (With the contact inserted)**

**Packaging style**  
Pipe

▶ Product table / Dimensions

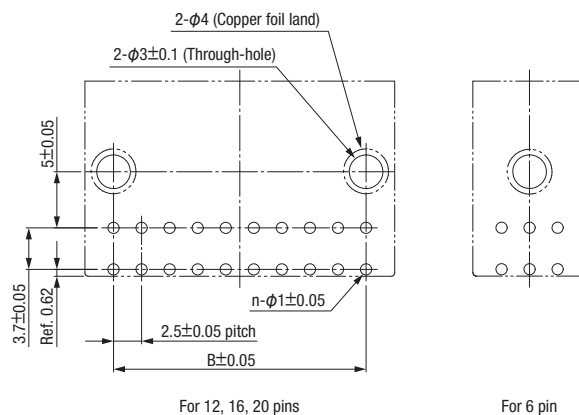
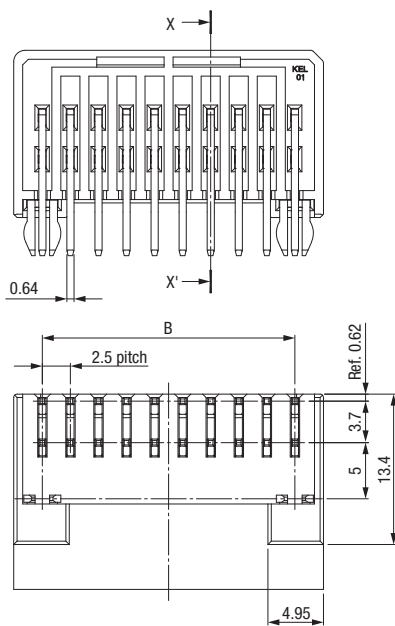
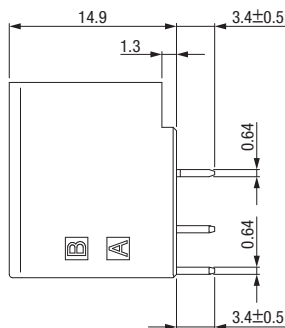
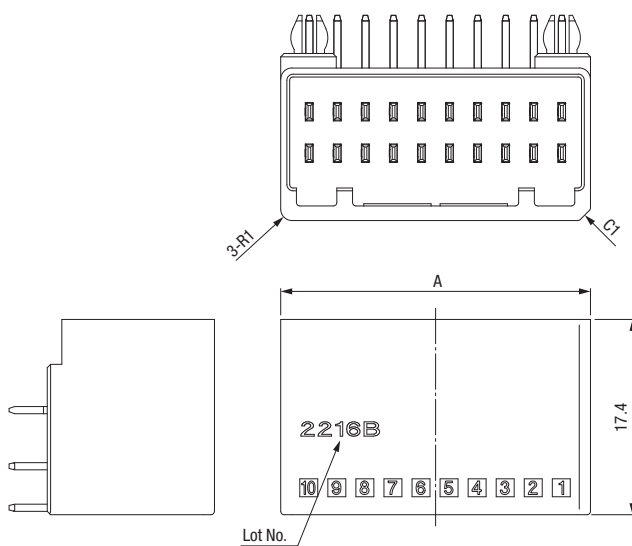
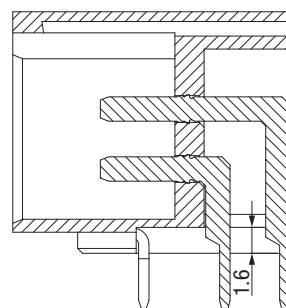
No. of contacts	Part number	A	B	No. of packaging
6	FTCS11-06S□	10.1	5.0	49
12	FTCS11-12S□	17.6	12.5	28
20	FTCS11-20S□	27.6	22.5	18

**Printed Circuit Board layout (Component side view)**

 Applicable board thickness  $t=1.6$  to  $2.4$   
 "n" is number of contacts.

**X-X' Cross section**

 Packaging style  
 Pipe

**Product table / Dimensions**

No. of contacts	Part number	A	B	No. of packaging
6	FTCS11-06L□	10.1	5.0	48
12	FTCS11-12L□	17.6	12.5	27
16	FTCS11-16L□	22.6	17.5	21
20	FTCS11-20L□	27.6	22.5	17

# FTCS12-□□P (Plug, Cable-relay type)

Unit : mm

## ▶ Panel layout (Component side view)

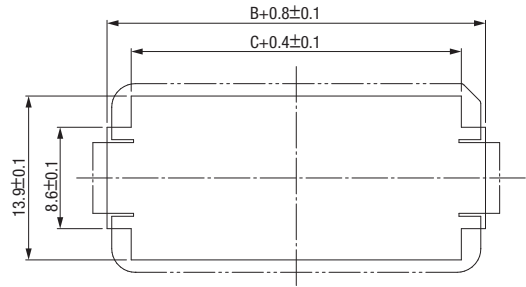

Applicable board thickness  $t=0.8$  to  $2.0$

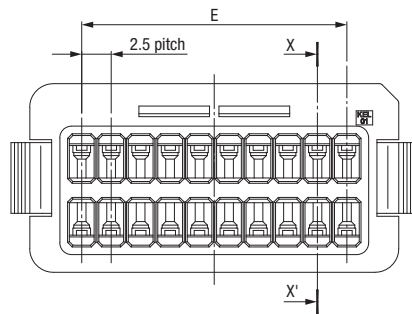
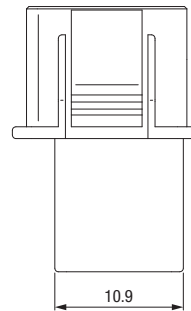
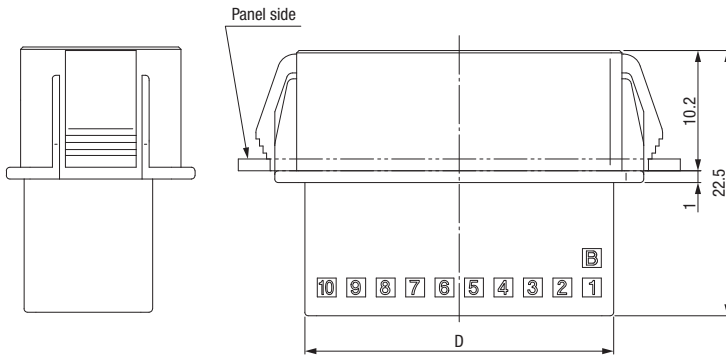
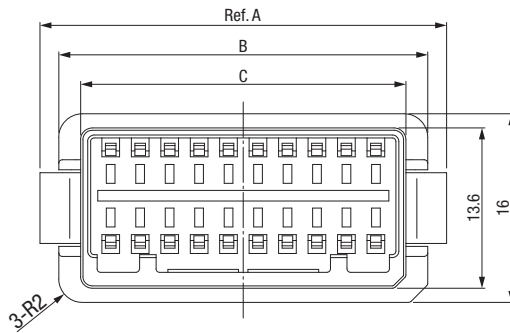

## X-X' Cross section (With the contact inserted)

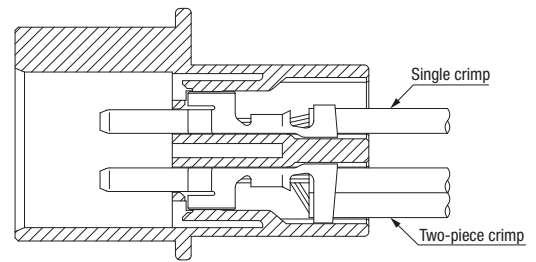

Packaging style  
Pipe

## ▶ Product table / Dimensions

No. of contacts	Part number	A	B	C	D	E	No. of packaging
6	FTCS12-06P	17.5	13.8	10.1	8.7	5.0	400
12	FTCS12-12P	25.0	21.3	17.6	16.2	12.5	300
20	FTCS12-20P	35.0	31.3	27.6	26.2	22.5	200

Please contact our sales representative.

## KEL Company Profile

Trade Name: KEL CORPORATION  
Established : July 23, 1962  
Total Capital: 1,617 Million Yen  
President : Akira Kasuga  
Head Office : 6-17-7 Nagayama, Tama,  
Address Tokyo 206-0025, Japan  
URL : [www.kel.jp](http://www.kel.jp)

### Factories

- Yamanashi Factory (Nishi-Yatsushiro, Yamanashi)
- Nagano Factory (Kita-azumi, Nagano)
- Minami-Alps Factory (Minami-Alps, Yamanashi)

## B.C.E. s.r.l.

Via Regina Pacis, 54/c - 41049 SASSUOLO (MO) Italy  
Tel. +39 0536 811.616 r.a. - Fax +39 0536 811.500  
[www.bce.it](http://www.bce.it) - E-mail: [bce@bce.it](mailto:bce@bce.it)

[www.kel.jp](http://www.kel.jp)

KEL provides the products from a connector to a rack.

**KEL CORPORATION**

## Global Network



More Information  
[https://www.kel.jp/feature/floating\\_lp\\_2](https://www.kel.jp/feature/floating_lp_2)



**B.C.E. S.r.l.**

Via Regina Pacis, 54/c - I 41049 Sassuolo (MO)  
Tel.: (+39) 0536 811616 - Fax.: (+39) 0536 811500

e-mail: [bce@bce.it](mailto:bce@bce.it) - Website: [www.bce.it](http://www.bce.it)