

REV.	DESCRIPTION	DATE
A	ISSUE	Dec/05/2013

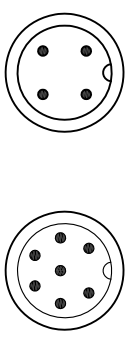

CPP-P104DSF CPP-P107DSF

ROHS

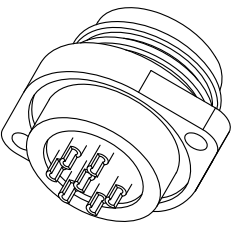
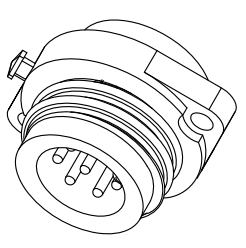
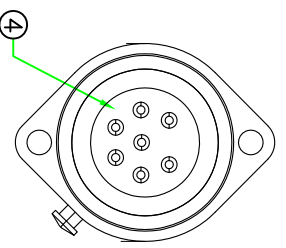
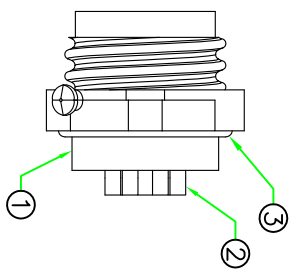
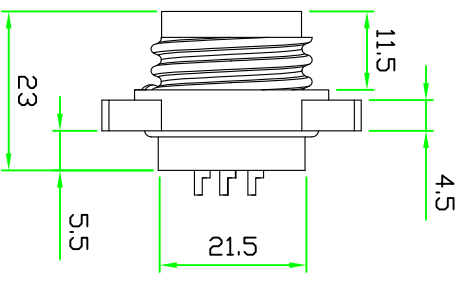
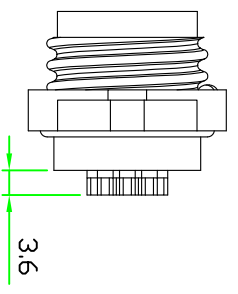
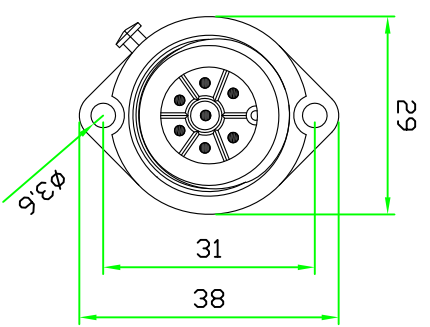
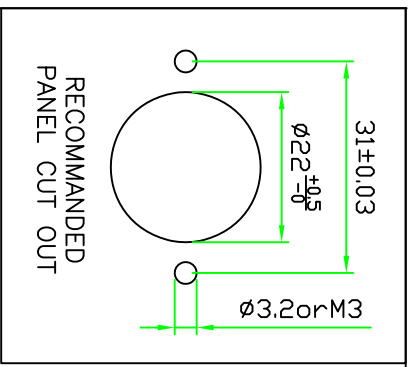
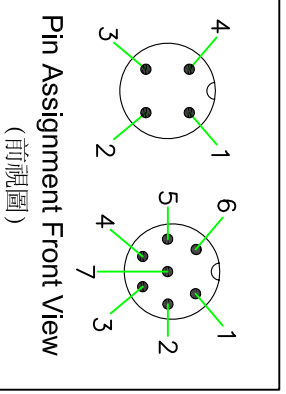

No.	PART NAME	DESCRIPTION	COLOR	Q'TY	REMARKS
3	GLUE	EPOXY.	BLACK	1	
3	O-RING	NBR.	BLACK	1	O-1620-EK
2	CONTACT	BRASS, MALE PIN, 6u" GOLD PLATED.		N	M1:SSPL24.5
1	CONNECTOR	NYLON+GF.	BLACK	1	CPP-P11xxC (190-135)

HOLIN® HTP ASIA TECHNOLOGY CO., LTD.
禾凌科技股份有限公司

UNLESS OTHERWISE SPECIFIED TOLERANCES:
 X ±0.25 XX ±0.1
 XXX ±0.05 ANGLE ±1°

SCALE: 1:1 UNIT: mm

TITLE: CIRCULAR P SIZE MALE SOLDER PIN SCREW TYPE ROUND FLANGE SCREW MOUNT PANEL CONNECTOR

P/N: CPP-P1xxDSF
 CH. MICHAEL
 DR. JACK

DWG.NO: CPP-P1xxDSF
 AP.

REV: A SHEET 1/1