

RoHS

IP66-68

REV.	DESCRIPTION	DATE
A	ISSUE	Oct/30/2015

Ref.

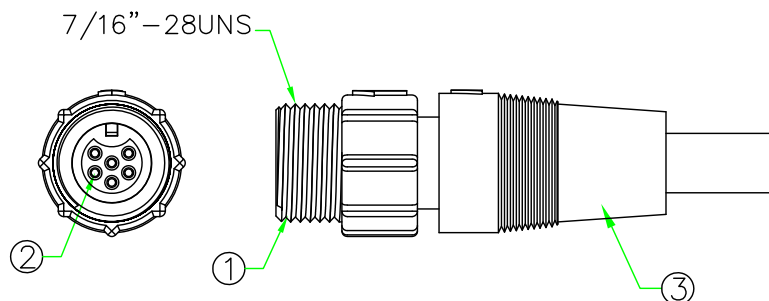
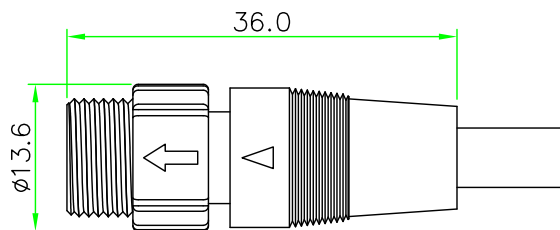
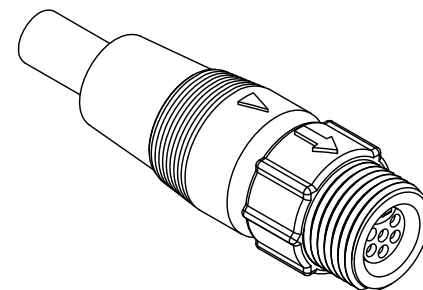

NOTES:

- ELECTRICAL CHARACTERISTICS:  
 CURRENT RATING: 2A / 5A  
 CONNECTOR TEMPERATURE RANGE: -20°C TO +80°C  
 DIELECTRIC WITHSTANDING VOLTAGE:  
 500V AC FOR ONE MINUTE
- HOW TO ORDER: CA<sub>x</sub>-P3<sub>xx</sub>SN

- 02 - 2 PIN    04 - 4 PIN
- 03 - 3 PIN    05 - 5 PIN
- 06 - 6 PIN
- D - CURRENT RATING 5A
- N - CURRENT RATING 2A

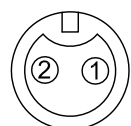

CAD-P302SN

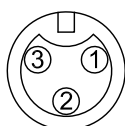

CAD-P303SN

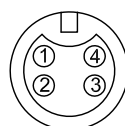

CAN-P304SN

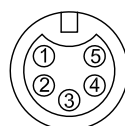

CAN-P305SN

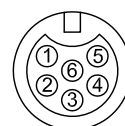

CAN-P306SN

PIN ASSIGNMENT FRONT VIEW  
(前視圖)

3	OVERMOLD	PVC or PU.	BLACK	1	
2	CONTACT	Brass, 6u" Gold Plated. Female Pin.		N	
1	CONNECTOR	A Size Male Connector Insert, NYLON+GF.	BLACK	1	
No.	PART NAME	DESCRIPTION	COLOR	Q'TY	REMARKS

HOLIN <sup>®</sup> HTP ASIA TECHNOLOGY CO., LTD. 禾凌科技股份有限公司					
		UNIT: mm	TITLE :	Circular A Size Screw Type Male Connector Female Pin Molded Cable	
SCALE	1.5:1	P/N:		CA <sub>x</sub> -P3 <sub>xx</sub> SN	
UNLESS OTHERWISE SPECIFIED TOLERANCES:		DR.		Patty	
x ±0.5	xx ±0.25	CH.		ERIC	
xxx ±0.1	ANGLE ± 1'	AP.			
REV. A	SHEET 1/1	DWG.NO:		CA <sub>x</sub> -P3 <sub>xx</sub> SN	