

RoHS

IP66~68

REV.	DESCRIPTION	DATE
A	ISSUE	July/05/2007
A1	Update Drawing	Sep/29/2014

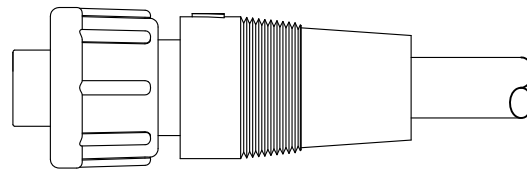
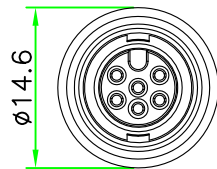
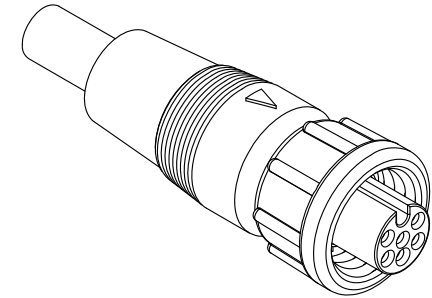
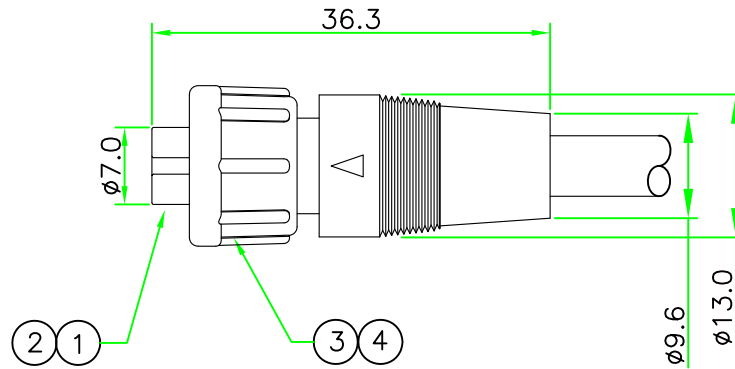

NOTES:

1. ELECTRICAL CHARACTERISTICS:

CURRENT RATING: 2A / 5A

CONNECTOR TEMPERATURE RANGE: -20°C TO +80°C

DIELECTRIC WITHSTANDING VOLTAGE:

500V AC FOR ONE MINUTE

2. HOW TO ORDER: CA_x-P2_{xx}SN

- 02 - 2 PIN 04 - 4 PIN
- 03 - 3 PIN 05 - 5 PIN
- 06 - 6 PIN

- D - CURRENT RATING 5A
- N - CURRENT RATING 2A

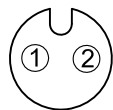

CAD-P202SN

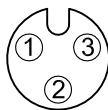

CAD-P203SN

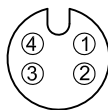

CAN-P204SN

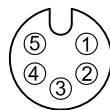

CAN-P205SN

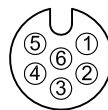

CAN-P206SN

PIN ASSIGNMENT FRONT VIEW
(前視圖)

4	SCREW NUT	NYLON+GF	BLACK	1	
3	O-RING	Silicon.	BLACK	1	
2	CONTACT	Brass , 6 u" Gold Plated .Female Contact.		N	
1	CONNECTOR	A Size Female Connector Insert.NYLON+GF.	BLACK	1	
No.	PART NAME	DESCRIPTION	COLOR	Q'TY	REMARKS

HOLIN[®] HTP ASIA TECHNOLOGY CO., LTD.
禾凌科技股份有限公司

	UNIT: mm	TITLE :	Circular A Size Female Connector Screw Type Molded Cable	
SCALE	1 : 1	P/N:	CA _x -P2 _{xx} SN	DR. Patty
UNLESS OTHERWISE SPECIFIED TOLERANCES:				CH. ERIC
.X ± 0.25 .XX ± 0.1				
.XXX ± 0.05 ANGLE ± 1°				
REV.	SHEET	DWG.NO:	CA _x -P2 _{xx} SN	AP.
A1	1/1			