

REV.	DESCRIPTION	DATE
A	ISSUE	Jan/14/2015
A1	Modify Gasket Thickness	Jun/18/2015
B	Change Design	Oct/20/2015

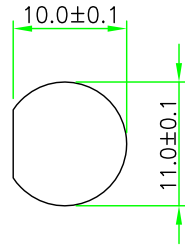

RECOMMENDED
PANEL CUT OUT

P/N	D
CAD	ø1.0
CAN	ø0.8

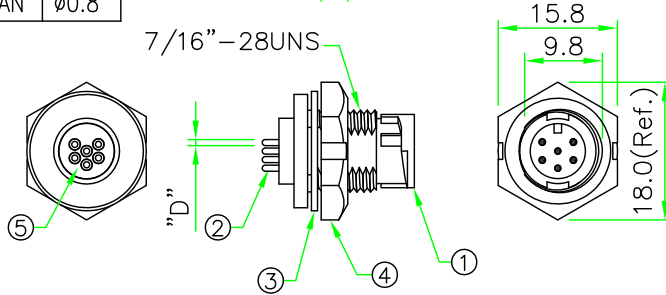
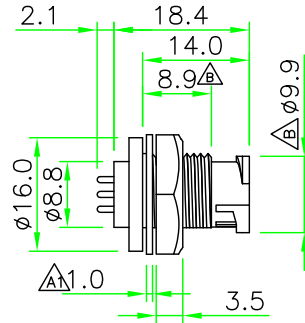

RoHS
IP66~68

OLD P/N:CAx-L1xxCPR
(原型號)

NOTES:

- ELECTRICAL CHARACTERISTICS:
CURRENT RATING: 2A / 5A
CONNECTOR TEMPERATURE RANGE: -25°C TO +85°C
DIELECTRIC WITHSTANDING VOLTAGE:
500V AC FOR ONE MINUTE
- MAXIMUM PANEL THICKNESS:3.2mm
- HOW TO ORDER: CAx-L1xxCPR

02 - 2 PIN 04 - 4 PIN
03 - 3 PIN 05 - 5 PIN
06 - 6 PIN

D - CURRENT RATING 5A
N - CURRENT RATING 2A

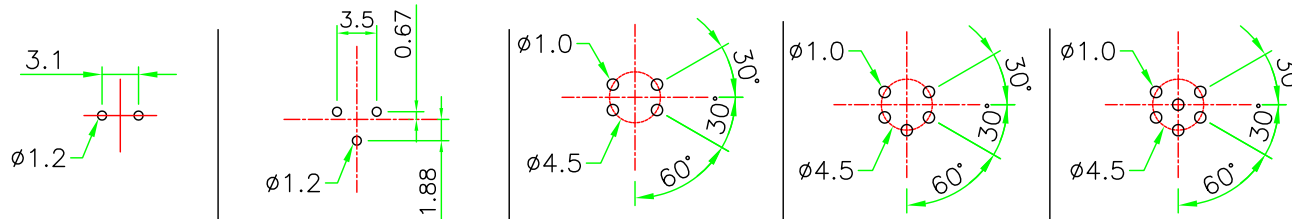

PCB LAYOUT

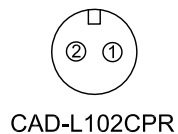

CAD-L102CPR

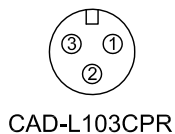

CAD-L103CPR

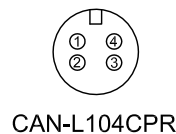

CAN-L104CPR

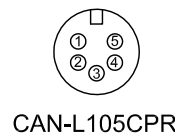

CAN-L105CPR

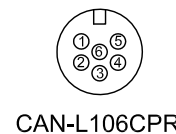

CAN-L106CPR

PIN ASSIGNMENT FRONT VIEW
(前視圖)

HOLIN® HTP ASIA TECHNOLOGY CO., LTD.
禾凌科技股份有限公司

	UNIT: mm	TITLE	Circular A Size Male Connector Male Pin Rear Mount Lock Type Round Flange PCB Pin	
SCALE	1:1			
UNLESS OTHERWISE SPECIFIED TOLERANCES:		P/N:	CAx-L1xxCPR	DR. Patty
.x ± 0.5	.xx ± 0.25			CH. ERIC
.xxx ± 0.1	ANGLE ± 1°	REV.	CAx-L1xxCPR	AP.
B	SHEET 1/1	DWG.NO:		

No.	PART NAME	DESCRIPTION	COLOR	Q'TY	REMARKS
4	HEX NUT	NYLON+GF.	BLACK	1	
3	GASKET	EPDM.	BLACK	1	
2	CONTACT	Brass , 6 u" Gold Plated . Male Contact.		N	
1	CONNECTOR	A Size Male Connector Insert.NYLON+GF.	BLACK	1	