

## 58 Series Pressure Switch With Digital Display

### GPD-58...

- Compact, rugged construction, High over pressure
- ceramic Al<sub>2</sub>O<sub>3</sub> as the sensor
- Clearly readable display, Sensitive operation keys
- Diagnostic function
- suitable for an extremely wide range of demanding industrial applications, Especially the sewage treatment plant
- Certified : 
- Connector : page 71
- Accessories : page 71
- dimensional drawing : page 72
- Wiring diagram : page 72
- -----

Pressure Switch type (1)		GPD-582-025B-...	GPD-588-025B-...
Medium		Liquids and gases	
Pressure range		0 ... 25 bar, Relative (2)	
Max. allowable pressure		87.5 bar / 87.5 bar	
Power supply		17 ... 33 VDC	
Rated operation current (Digital output)		200 mA	
Temperature		-20 ... +80 °C	
Protection class		IP67	
Materials in contact with the medium	Pressure connection	Stainless steel 1.4404 / AISI 316L	
	Sensor	ceramic Al <sub>2</sub> O <sub>3</sub> (96%)	
	Sealing material	FPM	
Current consumption		≤ 50 mA	
Load resistance	4...20 mA Current output	< 0.5 kΩ	
	0...10 V Voltage output	>10 kΩ	
Response time		≤ 5 ms	
Electrical protection		Short circuit proof and protected against polarity reversal. Each connection is protected against crossover up to max. supply voltage.	
TC		≤ ± 0.2 % fs /10 K	
Total of linearity hysteresis and repeatability		≤ ± 0.5 % fs	
Tolerance zero point		≤ ± 0.1 % fs	
Shock		50 g(11ms half sine wave), acc. IEC 60068-2-27	
Vibration		20 g (10 ... 2000 Hz), acc. IEC 60068-2-6	
Electrical connection(3)		Connector M12x1, Metal thread	
Pressure connection(4)		G1/4" Inside thread, with O-Ring sealing	G1/4" Outside thread , DIN 3852
Output type —Type, Order No.	4...20 mA Current output +1 DO(PNP)	GPD-582-025B-3 , A5158105	GPD-588-025B-3 , A5758105
	0...10 V Voltage output + 1 DO(PNP)	GPD-582-025B-4 , A5158106	GPD-588-025B-4 , A5758106
	2 DO(PNP)	GPD-582-025B-2 , A5158104	GPD-588-025B-2 , A5758104
	4...20 mA Current output +2 DO(PNP)	GPD-502-025B-5 , A5158107	GPD-588-025B-5 , A5758107
	0...10 V Voltage output + 2 DO(PNP)	GPD-502-025B-6 , A5158108	GPD-588-025B-6 , A5758108

(1)Other types please see "type selection guide" or ask relative PM

(2)Types with absolute pressure measuring haven't provided at present, ask PM if necessary

(3)Other types with different electric connection please see dimension drawing and ask relative PM at the same time

(4)Other types with different pressure connection please see dimension drawing and ask relative PM at the same time



GPD-582-040B-...	GPD-588-040B-...	
Liquids and gases		
0 ... 40 bar, Relative (2)		
140 bar / 140 bar		
17 ... 33 VDC		
200 mA		
-20 ... +80 °C		
IP67		
Stainless steel 1.4404 / AISI 316L		
ceramic Al2O3 (96%)		
FPM		
≤ 50 mA		
< 0.5 kΩ		
>10 kΩ		
≤ 5 ms		
Short circuit proof and protected against polarity reversal. Each connection is protected against crossover up to max. supply voltage.		
≤ ± 0.2 % fs /10 K		
≤ ± 0.5 % fs		
≤ ± 0.1 % fs		
50 g(11ms half sine wave), acc. IEC 60068-2-27		
20 g (10 ... 2000 Hz), acc. IEC 60068-2-6		
Connector M12x1, Metal thread		
G1/4" Inside thread, with O-Ring sealing FPM spez.	G1/4" Outside thread , DIN 3852	
GPD-582-040B-3 , A5159105	GPD-588-040B-3 , A5759105	
GPD-582-040B-4 , A5159106	GPD-588-040B-4 , A5759106	
GPD-582-040B-2 , A5159104	GPD-588-040B-2 , A5759104	
GPD-582-040B-5 , A5159107	GPD-588-040B-5 , A5759107	
GPD-582-040B-6 , A5159108	GPD-588-040B-6 , A5759108	

(1)Other types please see "type selection guide" or ask relative PM

(2)Types with absolute pressure measuring haven't provided at present, ask PM if necessary

(3)Other types with different electric connection please see dimension drawing and ask relative PM at the same time



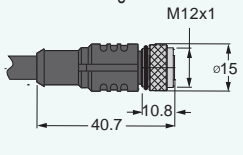
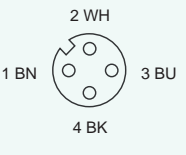
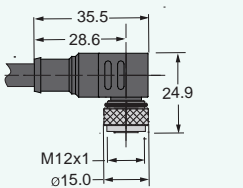
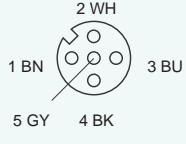
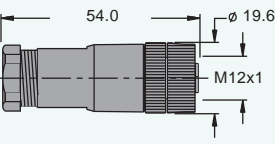
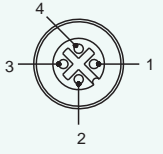
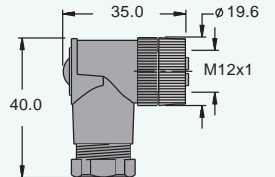
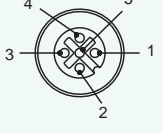

(4)Other types with different pressure connection please see dimension drawing and ask relative PM at the same time

## 58 Series Pressure Switch With Digital Display

Electrical connections (5)		(5)Other connector types please ask connector product manager				
<b>Precast cable</b>		<b>Pin Number</b>	<b>Cable Length</b>	<b>Order code</b>	<b>Type</b>	
<b>M12x1 Straight male Connector</b> 		4	2m	10011010	EK4-2M/P00	
		5	5m	10011011	EK4-5M/P00	
		5	10m	10011012	EK4-10M/P00	
		5	2m	10011020	EK4.5-2M/P00	
		5	5m	10011021	EK4.5-5M/P00	
		5	10m	10011022	EK4.5-10M/P00	
<b>M12x1 Angle male Connector</b> 		4	2m	10011040	ELK4-2M/P00	
		4	5m	10011041	ELK4-5M/P00	
		4	10m	10011042	ELK4-10M/P00	
		5	2m	10011050	ELK4.5-2M/P00	
		5	5m	10011051	ELK4.5-5M/P00	
		5	10m	10011052	ELK4.5-10M/P00	
<b>Swift connector</b>		<b>Pin Number</b>	<b>Cable diameter</b>	<b>Outlet</b>	<b>Order code</b>	<b>Type</b>
<b>M12x1 Straight Female Connector</b> 		4	4-6 mm	PG7	10091000	EK4112-0/7
		4	6-8 mm	PG9	10091001	EK4112-0/9
		5	6-8 mm	PG9	10091002	EK5112-0/9
<b>M12x1 Angle Female Connector</b> 		4	4-6 mm	PG7	10091010	ELK4112-0/7
		4	6-8 mm	PG9	10091011	ELK4112-0/9
		5	6-8 mm	PG9	10091012	ELK5112-0/9
PBT , Black / Brass nickel plated, Spring-type terminals 85°C , 250 V , 4 A						

(6)Other mounting accessories types with different thread please ask relative product manager

Instruction	Type , Order code
-------------	-------------------

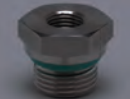
	Thread conversion device , G1/4" to G1/4" Outside thread Shell material: Stainless steel	GPA-G1/4M-G1/4M-A4 , B5130010
	Thread conversion device , G1/4" to G1/2" Outside thread Shell material: Stainless steel	GPA-G1/4M-G1/2M-A4 , B5140010
	Thread conversion device , G1/4" Inside thread to M20X1.5 Outside thread, Shell material: Stainless steel	GPA-G1/4M-M20X1.5M-A4 , B5180010
	Thread conversion device , G1/4" Inside to G1/4" Outside thread Shell material: Stainless steel	GPA-G1/4F-G1/4M-A4 , B5130110
	Thread conversion device , G1/4" Inside to G1/2" Outside thread Shell material: Stainless steel	GPA-G1/4F-G1/2M-A4 , B5140110

## Dimensional drawing

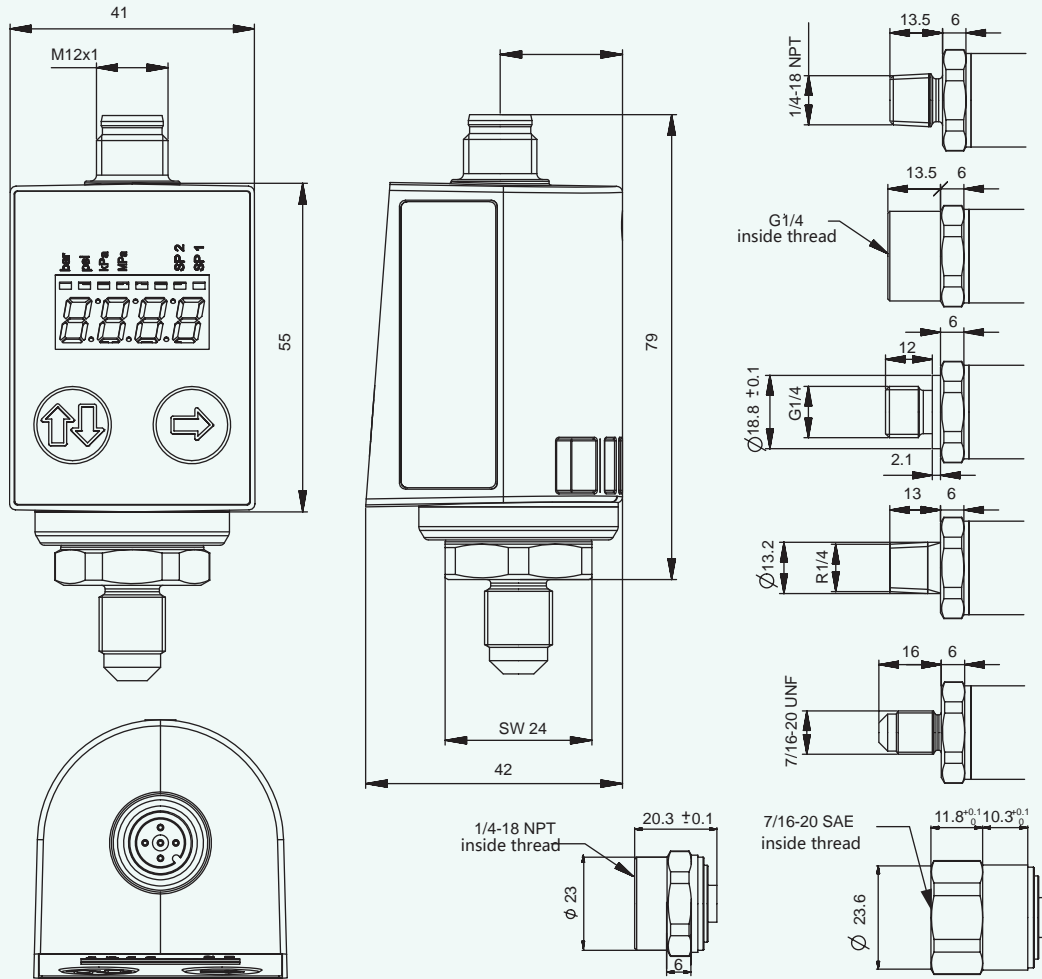

## Wiring diagram

### M12x1 circular connectors

