

XSLS SERIES

RoHS
Compliant

0.25mm PITCH CONNECTOR FOR MICRO COAXIAL CABLE (STACKING TYPE)



FEATURES

- ▶ Compact connector with a low profile of 1.44 mm(0.057") and a mating width of 3.05 mm(0.120").
- ▶ For micro coaxial cable (#42 AWG, #44 AWG, #46 AWG).
- ▶ Signal terminals are soldered by Pulse Heat in one shot and keep a stable & highly reliable connection.
- ▶ Equipped with a metal shell, noise reduction and product strength are ensured.
- ▶ Multiple ground terminals are provided for enhanced transmission characteristics and EMS protection.
- ▶ Highly reliable design with effective mating length of 0.31mm(0.012").
- ▶ Nickel barrier of the board side contact prevents solder wicking.
- ▶ Possible to put through narrow tube with a diameter of $\phi 2.7$ mm ($\phi 0.106$ "") even after soldering.
- ▶ The bottom of the connector is covered with resin, thus circuit may be printed under the connector.

*Specially designed withdrawal jig and caulking jig for a shell are also available.

ORDER CODE

XSLS0 - -

① ② ③

*Please order in multiples of the quantity per package.

- ① **[Type]** Receptacle (PCB side connector) **XSLS00** : With suction pick-up surface **XSLS01** : Without suction pick-up surface
- ② **[Number of contacts]** **30** : 30 pin **40** : 40 pin
- ③ **[Number of packaging]** **A** : 500pcs. per reel **B** : 3000pcs. per reel **C** : 5000pcs. per reel

ORDER CODE

XSLS20 - -

① ② ③

*Please order in multiples of the quantity per package.

- ① **[Type]** **XSLS20** : Plug (Cable side connector)
- ② **[Number of contacts]** **30** : 30 pin **40** : 40 pin
- ③ **[Number of packaging]** **Omit** : 10,000pcs. per reel **A** : 1,000pcs. per reel (Only 40 pin) **B** : 2,000pcs. per reel (Only 40 pin)

*Plug(cable side connector) is composed of a base and a shell.

The base is packed in embossed tape and reel (5,000pcs per reel) and the shell is packed in embossed tape and reel (10,000pcs per reel),therefore MOQ of the plug is 10,000pcs. Please contact your local KEL sales office for orders less than the MOQ 10,000pcs.

SPECIFICATIONS

	Material and finish	Electrical Characteristics	
Insulator material	[XSLS00]Glass-filled LCP(UL94V-0), Black	Current rating	0.3A per contact
	[XSLS20]Inorganic Filler LCP(UL94V-0), Black	Contact resistance	100mΩ max.
Contact material	Copper alloy	Dielectric withstanding voltage	100V AC for 1 minute
Contact plating	Gold over Nickel	Insulation resistance	50MΩ min. At 100V DC
Retention clip material	Copper alloy	Operating temperature	-40°C to +85°C
Retention clip plating	Gold over Nickel	Insertion and withdrawal durability	30 times
Shell material	Stainless	Recommended cable	#42/44/46 AWG Micro coaxial cables (Outermost diameter: max. 0.235 mm(0.009"))
Shell plating	Gold over Nickel		

Mating Drawing

Unit : mm(inch)

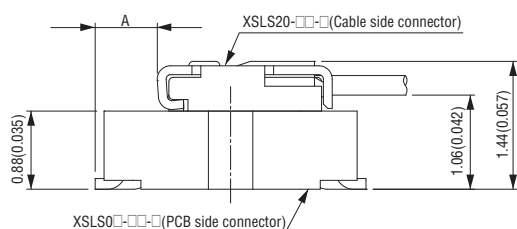

Dimensions

No. of contacts	A
30	0.70 (0.028)
40	0.68 (0.027)

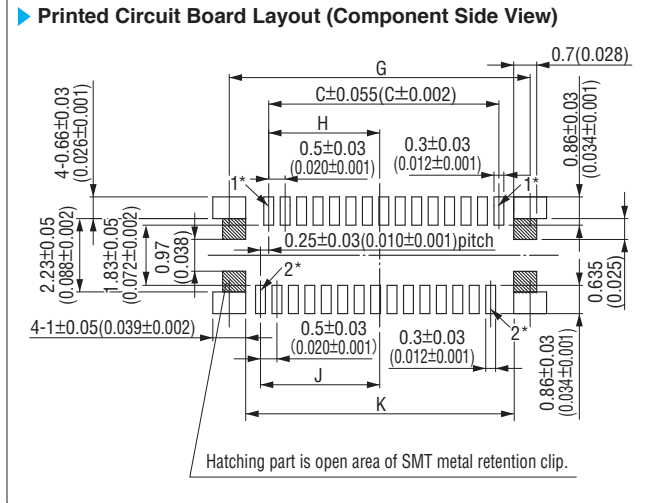
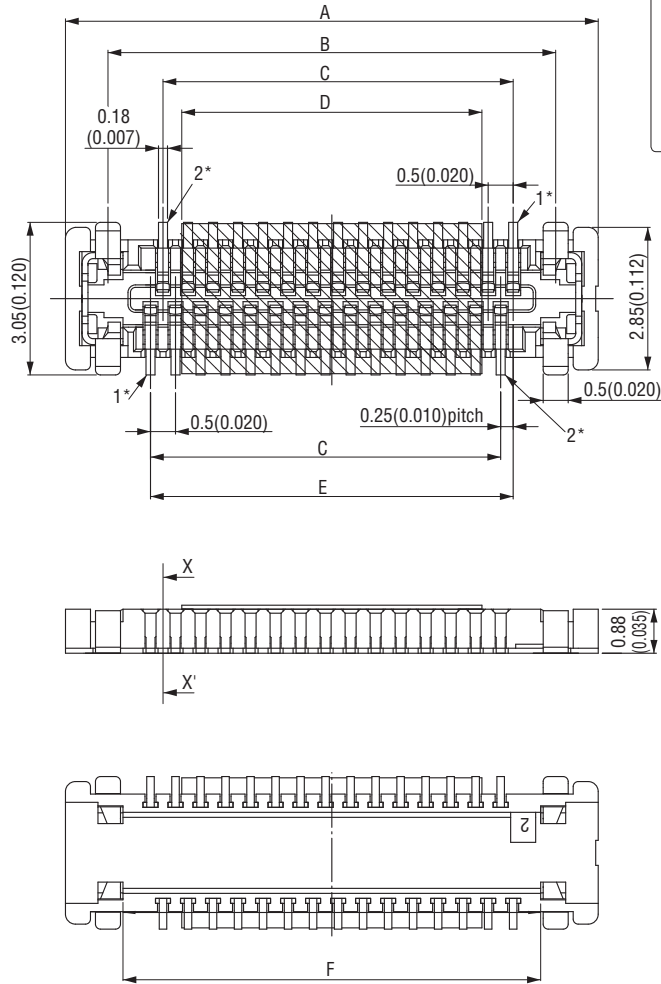
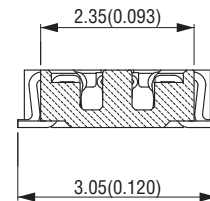
X-X' Cross Section

Ground Installation

No. of contacts	No. of ground
30	4
40	4

Packaging style

Embossed tape

Product Table

Part Number	Number of packaging
XLSL0□-□□-A	500
XLSL0□-□□-B	3,000
XLSL0□-□□-C	5,000

Product Table / Dimensions

No. of contacts	Part Number	A	B	C	D	E	F	G	H	J	K
30	XLSL0□-30-□	10.65 (0.419)	8.95 (0.352)	7.0 (0.276)	6.0 (0.236)	7.25 (0.285)	8.35 (0.329)	9.15 (0.360)	3.375 (0.133)	3.625 (0.143)	8.15 (0.321)
40	XLSL0□-40-□	13.15 (0.518)	11.45 (0.451)	9.5 (0.374)	6.0 (0.236)	9.75 (0.384)	10.85 (0.427)	11.65 (0.459)	4.625 (0.182)	4.875 (0.192)	10.65 (0.419)

XSLS20-□□-□ (Plug, Cable side connector)

Unit : mm(inch)

XSLS20-□□BASE-□

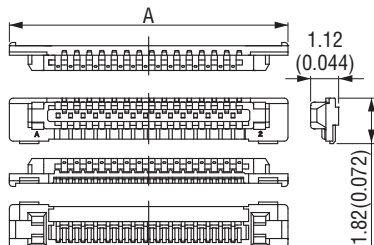

Part Number	Number of packaging
XSLS20-□□BASE	5,000
XSLS20-40BASE-A	1,000
XSLS20-40BASE-B	2,000

XSLS20-□□SHELL-□

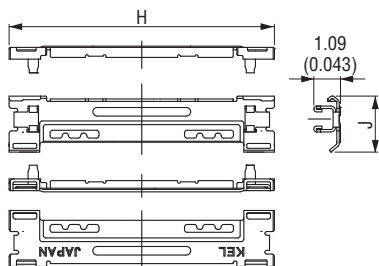

Part Number	Number of packaging
XSLS20-□□SHELL	10,000
XSLS20-40SHELL-A	1,000
XSLS20-40SHELL-B	2,000

*XSLS20-□□BASE-□ and XSLS20-□□SHELL-□ are component parts of XSLS20-□□-□.

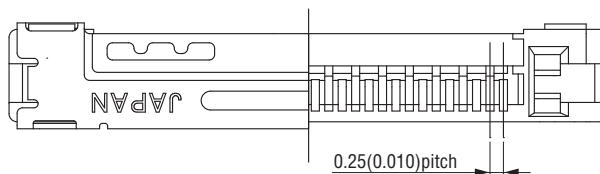
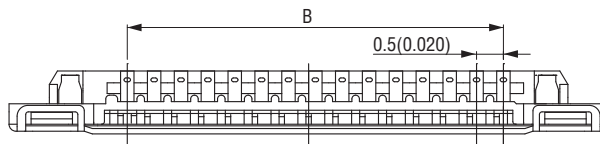
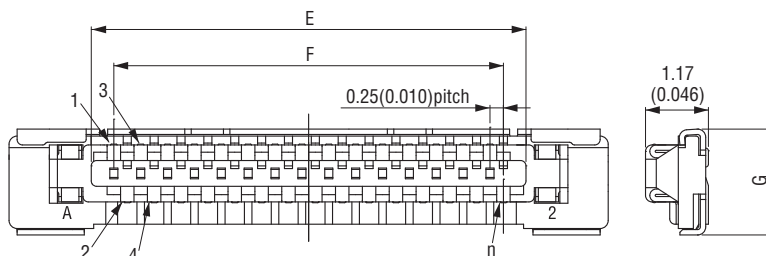
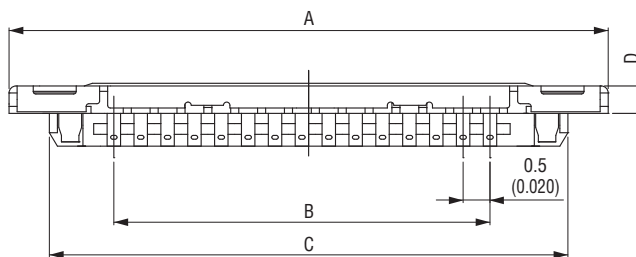

*"n" is number of contacts.

Packaging style
Embossed tape

Product Table

Part Number	Number of packaging
XSLS20-□□	10,000
XSLS20-40-A	1,000
XSLS20-40-B	2,000

Product Table / Dimensions

No. of contacts	Part Number	A	B	C	D	E	F	G	H	J
30	XSLS20-30	11.15 (0.439)	7.0 (0.276)	9.65 (0.380)	0.51 (0.020)	8.09 (0.319)	7.25 (0.285)	1.97 (0.078)	10.85 (0.427)	2.29 (0.090)
40	XSLS20-40-□	13.65 (0.537)	9.5 (0.374)	12.15 (0.478)	0.56 (0.022)	10.59 (0.417)	9.75 (0.384)	1.99 (0.078)	13.35 (0.526)	2.40 (0.094)

Printed Circuit Board Layout (for reference only)

The XLSL Series connector is designed to be rotationally symmetric and, thus, mounting or mating in either orientation is possible. Therefore, please be careful with the pin arrangement and mating orientation when inserting into a plug connector. For proper pin arrangement depending on the inserting direction into the plug connector (on the connector mounted surface), refer to the drawings below.

