

8900 SERIES

1.27mm PITCH LOW PROFILE CONNECTORS

RoHS
Compliant

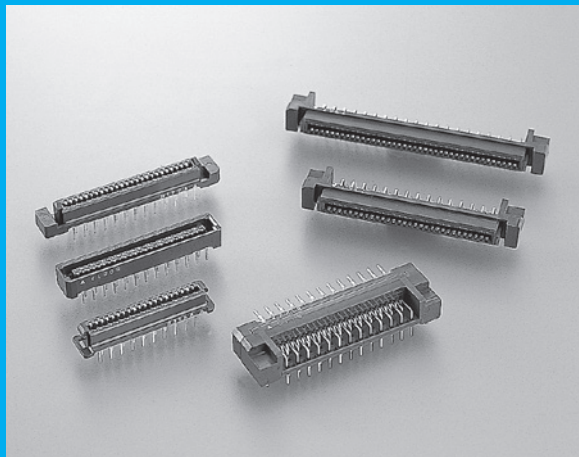

FEATURES

- ▶ Highly reliable contact design with independent and synchronized spring.
- ▶ Low insertion and withdrawal force.
- ▶ With a guide mechanism, smooth mating can be achieved.
- ▶ Insulator protects the contacts from damage or breakage.
- ▶ PPS insulator offers high temperature resistance.
- ▶ Stacked mating heights of 7, 8, 9, 10 and 12mm. (0.276, 0.315, 0.354, 0.394 and 0.472")
- ▶ Wide variations in the number of contacts (20, 30, 40, 50, 60, 80, 100 and 120 pins) are available.
- ▶ Audible "click" assures users of complete mating.
- ▶ Two types, with and without a flange, are available.
- ▶ 3 rows of terminals conserve board space. (Right angle type)

ORDER CODE

890 - - **177** - - **F**

① ② ③ ④ ⑤ ⑥ ⑦

*Please order in multiples of the quantity per package.

- | | |
|---|---|
| ① | [Type] Receptacle 8901 : With flanges and hooks 8903 : Without flanges and hooks |
| ② | [Number of contacts] 020 : 20pin 030 : 30pin 040 : 40pin 050 : 50pin 060 : 60pin 080 : 80pin 100 : 100pin 120 : 120pin |
| ③ | [Contact name] 177 |
| ④ | [Contact tail style] S : Straight L : Right angle (with flanges only) |
| ⑤ | [Plating of contact area] Omit : Au 0.05 μ m (Standard) D : Au 0.25 μ m (Upon request) |
| ⑥ | [Stacked height] (S type) A : 7, 9mm(0.276, 0.354") B : 8, 10mm(0.315, 0.394") D : 10, 12mm(0.394, 0.472") |
| ⑦ | [RoHS] F : RoHS Compliant |

*If you would like semi-customized products, please contact your local KEL sales office. *About 10mm mating height combinations, please refer next page.

ORDER CODE

891 - - **178** - - **F**

① ② ③ ④ ⑤ ⑥ ⑦

*Please order in multiples of the quantity per package.

- | | |
|---|---|
| ① | [Type] Plug 8911 : With flanges and hooks 8913 : Without flanges and hooks |
| ② | [Number of contacts] 020 : 20pin 030 : 30pin 040 : 40pin 050 : 50pin 060 : 60pin 080 : 80pin 100 : 100pin 120 : 120pin |
| ③ | [Contact name] 178 |
| ④ | [Contact tail style] S : Straight L : Right angle (with flanges only) |
| ⑤ | [Plating of contact area] Omit : Au 0.05 μ m (Standard) D : Au 0.25 μ m (Upon request) |
| ⑥ | [Stacked height] (S type) A : 7, 8, 10mm(0.276, 0.315, 0.394") C : 9, 10, 12mm(0.354, 0.394, 0.472") |
| ⑦ | [RoHS] F : RoHS Compliant |

*If you would like semi-customized products, please contact your local KEL sales office. *About 10mm mating height combinations, please refer next page.

SPECIFICATIONS

Material and plating		Electrical Characteristics	
Insulator material	Glass-filled PPS (UL94V-0), Brown	Current rating	0.5A per contact
Alignment plate material	Glass-filled Nylon 66 (UL 94V-0), Brown	Contact resistance	40mΩ max.
Contact material	Copper alloy	Dielectric withstanding voltage	650V AC for 1 minute
Contact plating	[890□] (Contact area) Gold over Nickel (Terminal area) Tin copper over Nickel [891□] Gold over Nickel	Insulation resistance	1,000MΩ min. at 500V DC
		Insertion force (Typical example)	18.62N max./ 20 pin, 37.24N max./ 40 pin, 55.86N max./ 60 pin, 93.10N max./ 100 pin
		Withdrawal force (Typical example)	2.94N min./ 20 pin, 5.88N min./ 40 pin, 8.82N min./ 60 pin, 14.70N min./ 100 pin
Retention clip material	Copper alloy	Operating temperature	-55°C to +85°C
Retention clip plating	Tin copper over Nickel		

Mating Drawing

Unit : mm(inch)

Horizontal Mating

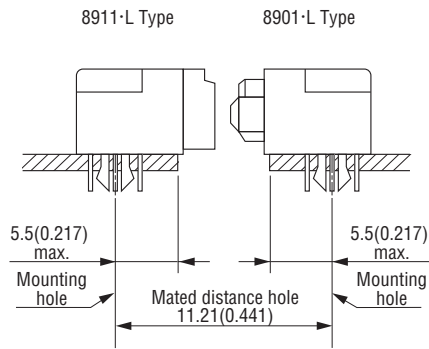

Vertical Mating

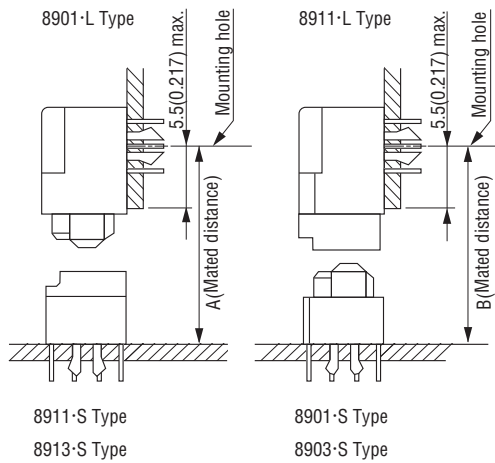

8911 8913	A
S-A	9.105 (0.359)
S-C	11.105 (0.437)

8901 8903	B
S-A	9.105 (0.359)
S-B	10.105 (0.398)
S-D	12.105 (0.477)

Stacked Mating

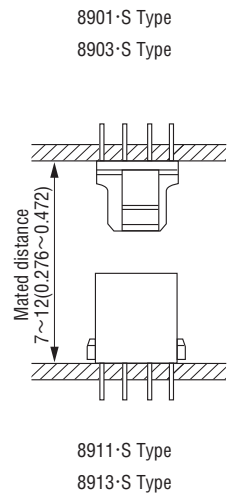

Additional mating combinations shown below.

8900 Series Stacked Mating Combinations

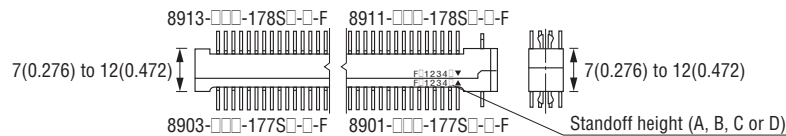

89□1series
with flanges and hooks

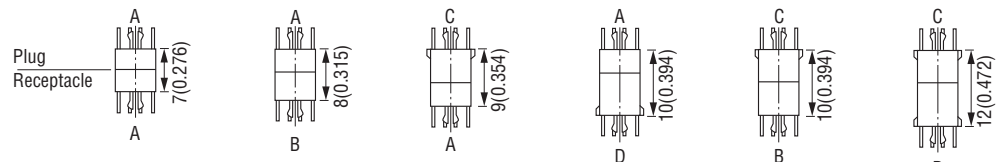

89□3series
without flanges and hooks

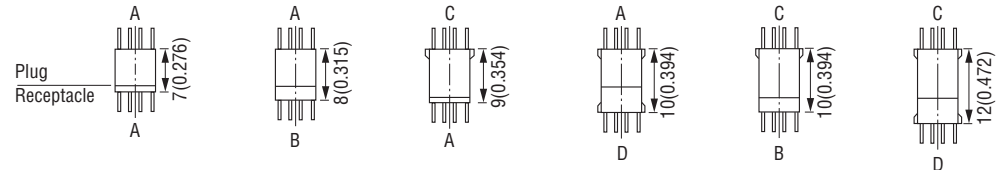

Selection Guide

Type	7mm (0.276inch)	8mm(0.315inch)	9mm(0.354inch)	10mm(0.394inch)	12mm(0.472inch)
With flanges and hooks	8911-□□-178S□-A-F	8911-□□-178S□-A-F	8911-□□-178S□-C-F	8911-□□-178S□-A-F 8901-□□-177S□-D-F	8911-□□-178S□-C-F
	8901-□□-177S□-A-F	8901-□□-177S□-B-F	8901-□□-177S□-A-F	8911-□□-178S□-C-F 8901-□□-177S□-B-F	8901-□□-177S□-D-F
	8913-□□-178S□-A-F	8913-□□-178S□-A-F	8913-□□-178S□-C-F	8913-□□-178S□-A-F 8903-□□-177S□-D-F	8913-□□-178S□-C-F
	8903-□□-177S□-A-F	8903-□□-177S□-B-F	8903-□□-177S□-A-F	8913-□□-178S□-C-F 8903-□□-177S□-B-F	8903-□□-177S□-D-F

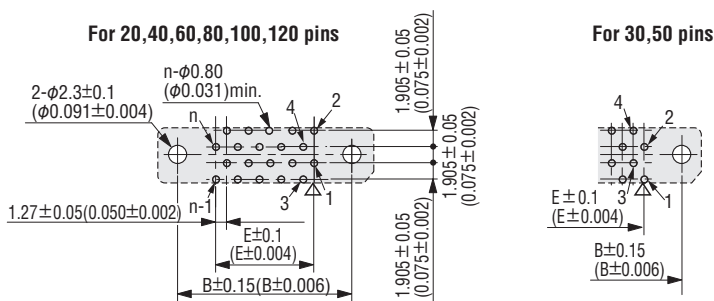
▶ Printed Circuit Board Layout (Component Side View)

 Recommended PCB Thickness $t=1.6\pm 0.19$ (0.063±0.007)

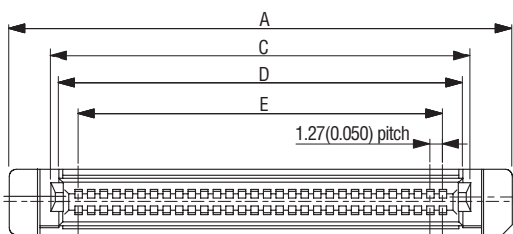
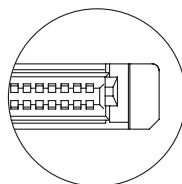
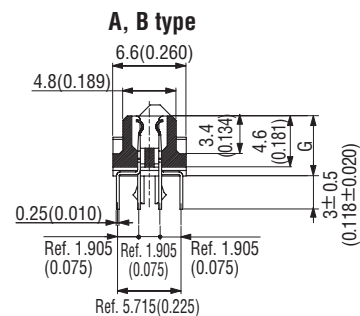
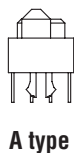
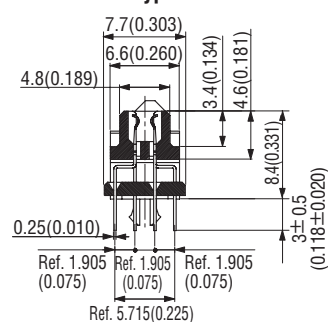
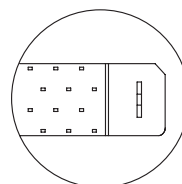
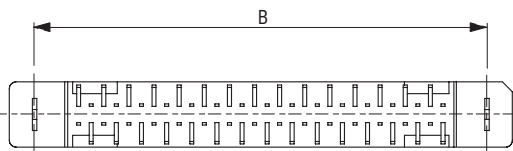
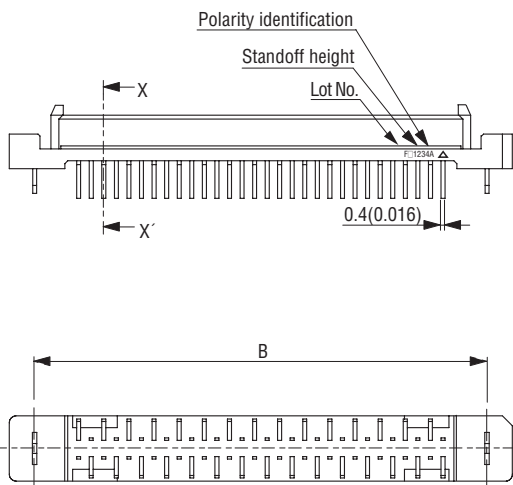
▽ = Polarity identification "n" is number of contacts.

A, B type

D type

X-X' Cross Section

D type

A type

Packaging style

Pipe

▶ Product Table / Dimensions

No. of contacts	Part Number	A	B	C	D	E	Number of packaging
20	8901-020-177S□-□-F	25.43 (1.001)	20.32 (0.800)	17.03 (0.670)	15.43 (0.607)	11.43 (0.450)	20
30	8901-030-177S□-□-F	31.78 (1.251)	26.67 (1.050)	23.38 (0.920)	21.78 (0.857)	17.78 (0.700)	16
40	8901-040-177S□-□-F	38.13 (1.501)	33.02 (1.300)	29.73 (1.170)	28.13 (1.107)	24.13 (0.950)	13
50	8901-050-177S□-□-F	44.48 (1.751)	39.37 (1.550)	36.08 (1.420)	34.48 (1.357)	30.48 (1.200)	11
60	8901-060-177S□-□-F	50.83 (2.001)	45.72 (1.800)	42.43 (1.670)	40.83 (1.607)	36.83 (1.450)	10
80	8901-080-177S□-□-F	63.53 (2.501)	58.42 (2.300)	55.13 (2.170)	53.53 (2.107)	49.53 (1.950)	7
100	8901-100-177S□-□-F	76.23 (3.001)	71.12 (2.800)	67.83 (2.670)	66.23 (2.607)	62.23 (2.450)	6
120	8901-120-177S□-□-F	88.93 (3.501)	83.82 (3.300)	80.53 (3.170)	78.93 (3.107)	74.93 (2.950)	5

Type	F	G
-A	3.5 (0.138)	5.4 (0.213)
-B	4.5 (0.177)	6.4 (0.252)
-D	6.5 (0.256)	-

8903-□□□-177S□-□-F (Receptacle, Without flanges and hooks, Straight)

Unit : mm(inch)

Printed Circuit Board Layout (Component Side View)

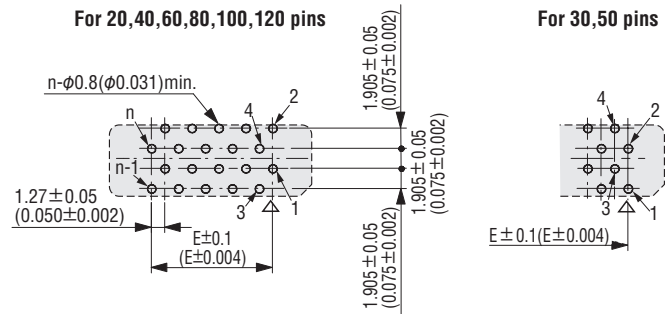

Recommended PCB Thickness $t=1.6\pm0.19$ (0.063±0.007)

▽ = Polarity identification "n" is number of contacts.

A, B type

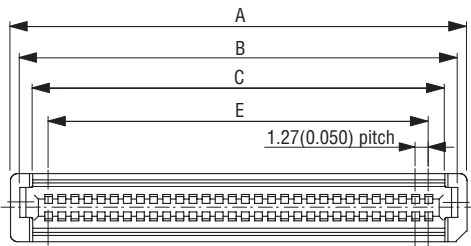

D type

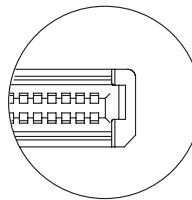

X-X' Cross Section

A, B type

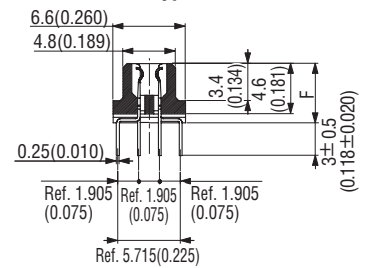

D type

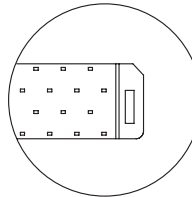
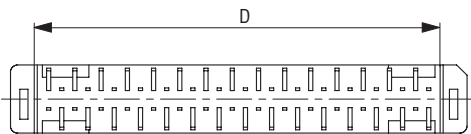
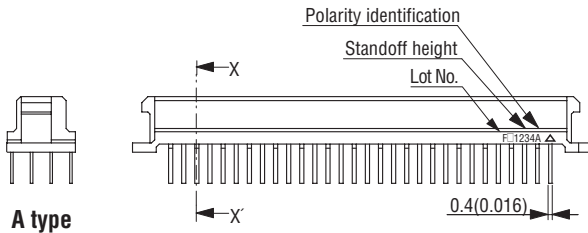
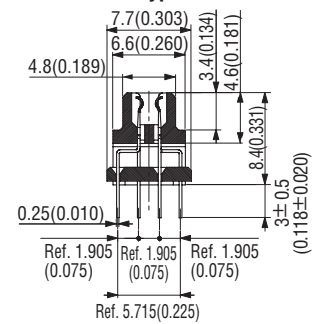

Packaging style
Pipe

Product Table / Dimensions

No. of contacts	Part Number	A	B	C	D	E	Number of packaging
20	8903-020-177S□-□-F	18.83 (0.741)	17.03 (0.670)	14.53 (0.572)	13.43 (0.529)	11.43 (0.450)	27
30	8903-030-177S□-□-F	25.18 (0.991)	23.38 (0.920)	20.88 (0.822)	19.78 (0.779)	17.78 (0.700)	20
40	8903-040-177S□-□-F	31.53 (1.241)	29.73 (1.170)	27.23 (1.072)	26.13 (1.029)	24.13 (0.950)	16
50	8903-050-177S□-□-F	37.88 (1.491)	36.08 (1.420)	33.58 (1.322)	32.48 (1.279)	30.48 (1.200)	13
60	8903-060-177S□-□-F	44.23 (1.741)	42.43 (1.670)	39.93 (1.572)	38.83 (1.529)	36.83 (1.450)	11
80	8903-080-177S□-□-F	56.93 (2.241)	55.13 (2.170)	52.63 (2.072)	51.53 (2.029)	49.53 (1.950)	8
100	8903-100-177S□-□-F	69.63 (2.741)	67.83 (2.670)	65.33 (2.572)	64.23 (2.529)	62.23 (2.450)	7
120	8903-120-177S□-□-F	82.33 (3.241)	80.53 (3.170)	78.03 (3.072)	76.93 (3.029)	74.93 (2.950)	6

Type	F
-A	5.4 (0.213)
-B	6.4 (0.252)

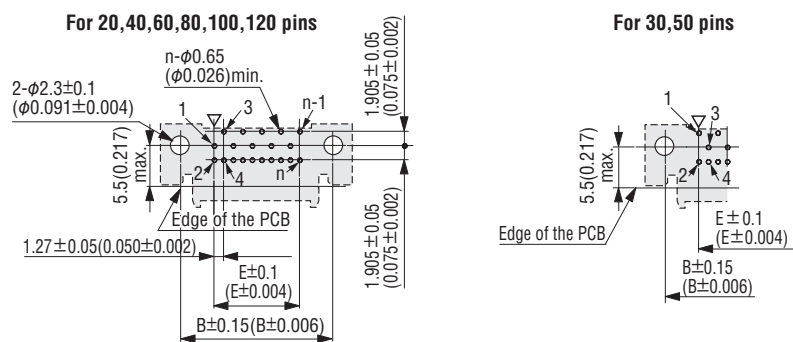
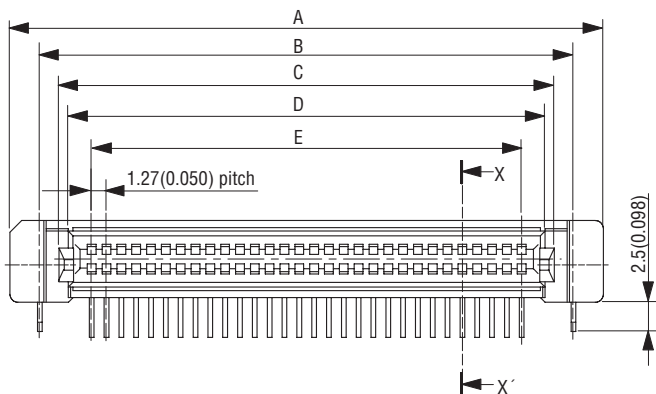
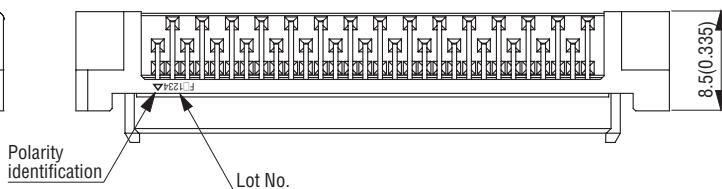
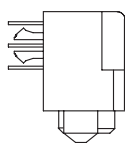
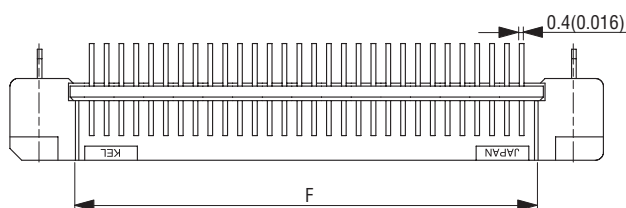
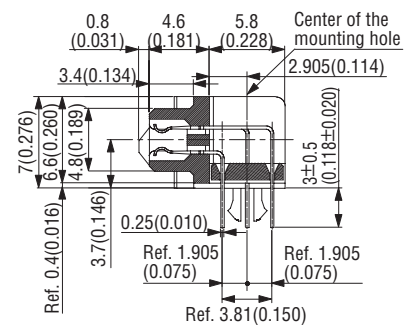
Printed Circuit Board Layout (Component Side View)

 Recommended PCB Thickness $t=1.6\pm 0.19$ (0.063±0.007) ▽ = Polarity identification "n" is number of contacts.

X-X' Cross Section

Packaging style

Pipe

Product Table / Dimensions

No. of contacts	Part Number	A	B	C	D	E	F	Number of packaging
20	8901-020-177L□-F	25.43 (1.001)	20.32 (0.800)	17.03 (0.670)	15.43 (0.607)	11.43 (0.450)	14.23 (0.560)	20
30	8901-030-177L□-F	31.78 (1.251)	26.67 (1.050)	23.38 (0.920)	21.78 (0.857)	17.78 (0.700)	20.58 (0.810)	16
40	8901-040-177L□-F	38.13 (1.501)	33.02 (1.300)	29.73 (1.170)	28.13 (1.107)	24.13 (0.950)	26.93 (1.060)	13
50	8901-050-177L□-F	44.48 (1.751)	39.37 (1.550)	36.08 (1.420)	34.48 (1.357)	30.48 (1.200)	33.28 (1.310)	11
60	8901-060-177L□-F	50.83 (2.001)	45.72 (1.800)	42.43 (1.670)	40.83 (1.607)	36.83 (1.450)	39.63 (1.560)	10
80	8901-080-177L□-F	63.53 (2.501)	58.42 (2.300)	55.13 (2.170)	53.53 (2.107)	49.53 (1.950)	52.33 (2.060)	8
100	8901-100-177L□-F	76.23 (3.001)	71.12 (2.800)	67.83 (2.670)	66.23 (2.607)	62.23 (2.450)	65.03 (2.560)	6
120	8901-120-177L□-F	88.93 (3.501)	83.82 (3.300)	80.53 (3.170)	78.93 (3.107)	74.93 (2.950)	77.73 (3.060)	5

8911-□□□-178S□-□-F (Plug, With flanges and hooks, Straight)

Unit : mm(inch)

Printed Circuit Board Layout (Component Side View)

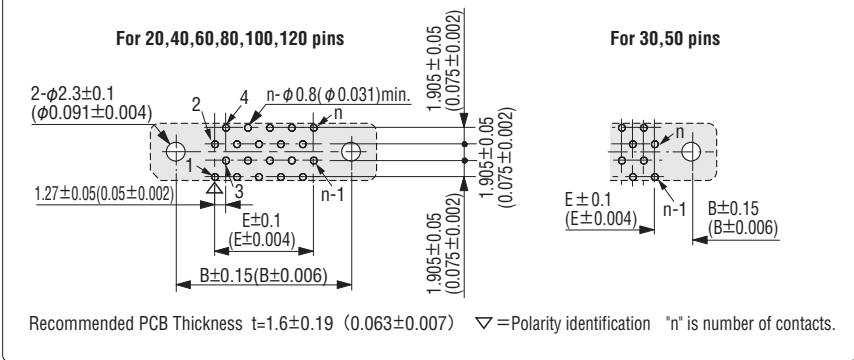

A type

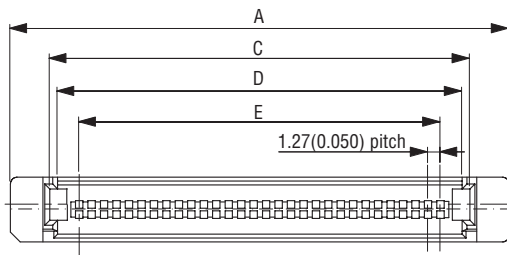

C type

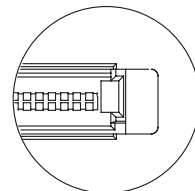

X-X' Cross Section

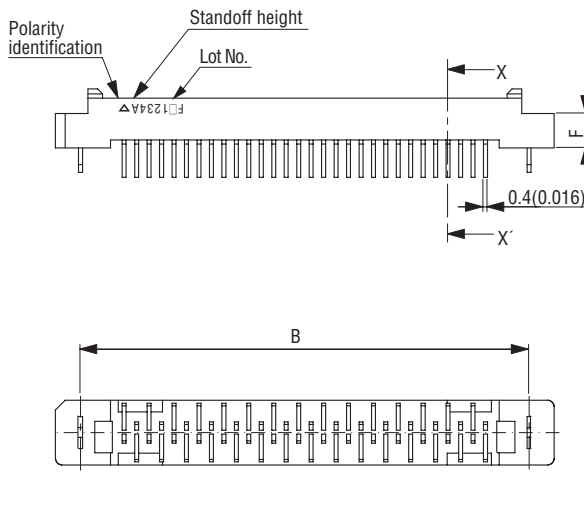
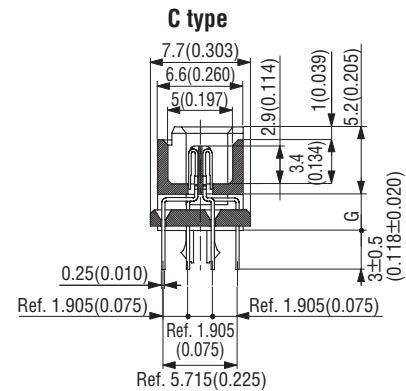
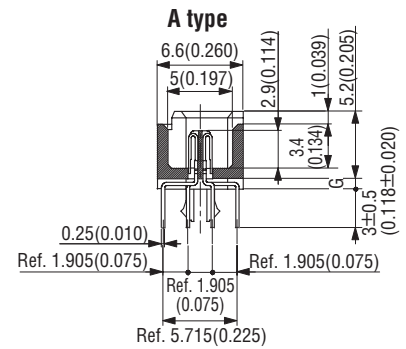

Packaging style
Pipe

Product Table / Dimensions

No. of contacts	Part Number	A	B	C	D	E	Number of packaging
20	8911-020-178S□-□-F	25.43 (1.001)	20.32 (0.800)	17.43 (0.686)	15.83 (0.623)	11.43 (0.450)	20
30	8911-030-178S□-□-F	31.78 (1.251)	26.67 (1.050)	23.78 (0.936)	22.18 (0.873)	17.78 (0.700)	16
40	8911-040-178S□-□-F	38.13 (1.501)	33.02 (1.300)	30.13 (1.186)	28.53 (1.123)	24.13 (0.950)	13
50	8911-050-178S□-□-F	44.48 (1.751)	39.37 (1.550)	36.48 (1.436)	34.88 (1.373)	30.48 (1.200)	11
60	8911-060-178S□-□-F	50.83 (2.001)	45.72 (1.800)	42.83 (1.686)	41.23 (1.623)	36.83 (1.450)	10
80	8911-080-178S□-□-F	63.53 (2.501)	58.42 (2.300)	55.53 (2.186)	53.93 (2.123)	49.53 (1.950)	7
100	8911-100-178S□-□-F	76.23 (3.001)	71.12 (2.800)	68.23 (2.686)	66.63 (2.623)	62.23 (2.450)	6
120	8911-120-178S□-□-F	88.93 (3.501)	83.82 (3.300)	80.93 (3.186)	79.33 (3.123)	74.93 (2.950)	5

Type	F	G
-A	3.5 (0.138)	0.8 (0.031)
-C	5.5 (0.217)	2.8 (0.110)

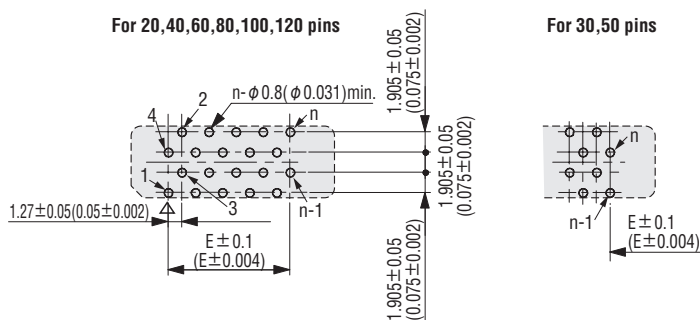
Printed Circuit Board Layout (Component Side View)

 Recommended PCB Thickness $t=1.6\pm 0.19$ (0.063±0.007)

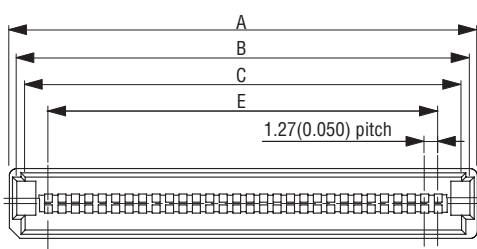
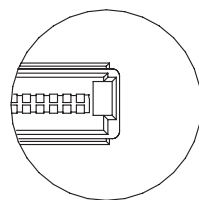
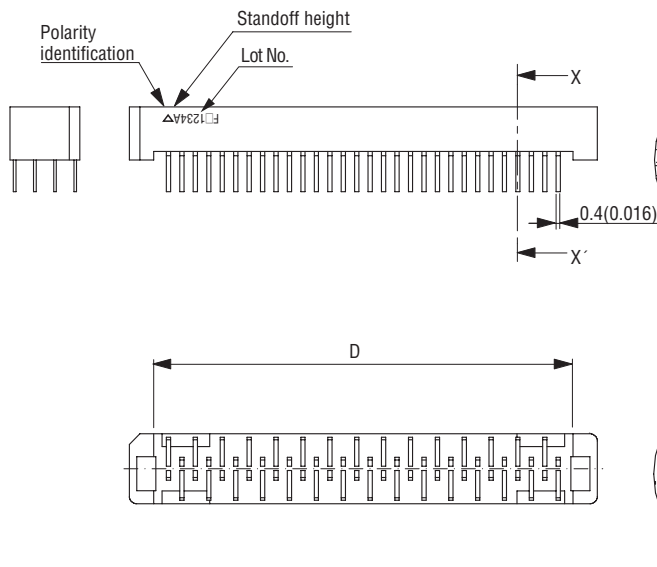
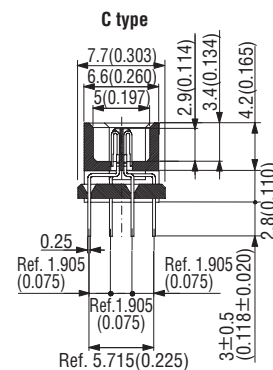
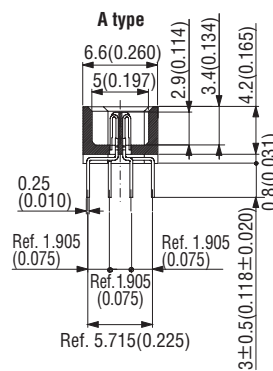
▽ = Polarity identification "n" is number of contacts.

A type

C type

X-X' Cross Section

Packaging style

Pipe

Product Table / Dimensions

No. of contacts	Part Number	A	B	C	D	E	Number of packaging
20	8913-020-178S□-□-F	18.83 (0.741)	17.43 (0.686)	15.83 (0.623)	14.23 (0.560)	11.43 (0.450)	27
30	8913-030-178S□-□-F	25.18 (0.991)	23.78 (0.936)	22.18 (0.873)	20.58 (0.810)	17.78 (0.700)	20
40	8913-040-178S□-□-F	31.53 (1.241)	30.13 (1.186)	28.53 (1.123)	26.93 (1.060)	24.13 (0.950)	16
50	8913-050-178S□-□-F	37.88 (1.491)	36.48 (1.436)	34.88 (1.373)	33.28 (1.310)	30.48 (1.200)	13
60	8913-060-178S□-□-F	44.23 (1.741)	42.83 (1.686)	41.23 (1.623)	39.63 (1.560)	36.83 (1.450)	11
80	8913-080-178S□-□-F	56.93 (2.241)	55.53 (2.186)	53.93 (2.123)	52.33 (2.060)	49.53 (1.950)	8
100	8913-100-178S□-□-F	69.63 (2.741)	68.23 (2.686)	66.63 (2.623)	65.03 (2.560)	62.23 (2.450)	7
120	8913-120-178S□-□-F	82.33 (3.241)	80.93 (3.186)	79.33 (3.123)	77.73 (3.060)	74.93 (2.950)	6

8911-□□□-178L□-F (Plug, With flanges and hooks, Right angle)

Unit : mm(inch)

▶ Printed Circuit Board Layout (Component Side View)

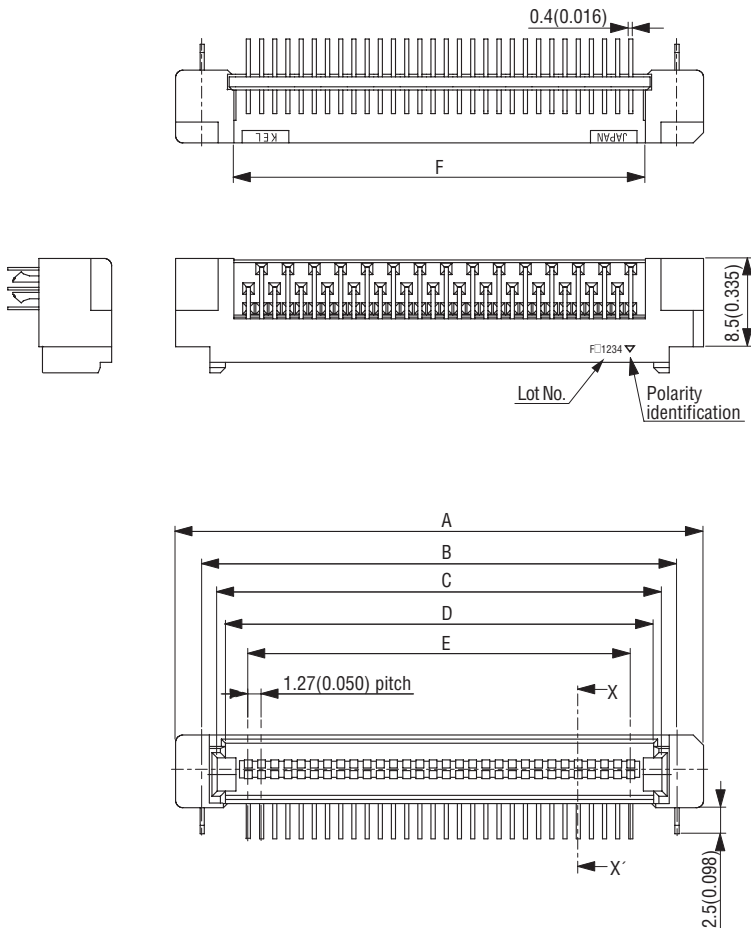
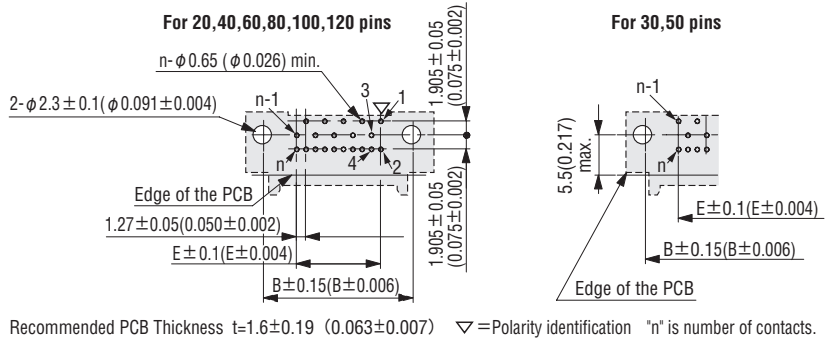

Packaging style
Pipe

▶ Product Table / Dimensions

No. of contacts	Part Number	A	B	C	D	E	F	Number of packaging
20	8911-020-178L□-F	25.43 (1.001)	20.32 (0.800)	17.43 (0.686)	15.83 (0.623)	11.43 (0.450)	14.23 (0.560)	20
30	8911-030-178L□-F	31.78 (1.251)	26.67 (1.050)	23.78 (0.936)	22.18 (0.873)	17.78 (0.700)	20.58 (0.810)	16
40	8911-040-178L□-F	38.13 (1.501)	33.02 (1.300)	30.13 (1.186)	28.53 (1.123)	24.13 (0.950)	26.93 (1.060)	13
50	8911-050-178L□-F	44.48 (1.751)	39.37 (1.550)	36.48 (1.436)	34.88 (1.373)	30.48 (1.200)	33.28 (1.310)	11
60	8911-060-178L□-F	50.83 (2.001)	45.72 (1.800)	42.83 (1.686)	41.23 (1.623)	36.83 (1.450)	39.63 (1.560)	10
80	8911-080-178L□-F	63.53 (2.501)	58.42 (2.300)	55.53 (2.186)	53.93 (2.123)	49.53 (1.950)	52.33 (2.060)	8
100	8911-100-178L□-F	76.23 (3.001)	71.12 (2.800)	68.23 (2.686)	66.63 (2.623)	62.23 (2.450)	65.03 (2.560)	6
120	8911-120-178L□-F	88.93 (3.501)	83.82 (3.300)	80.93 (3.186)	79.33 (3.123)	74.93 (2.950)	77.73 (3.060)	5