

# 8622E SERIES

## 0.635mm PITCH CONNECTOR FOR 0.635mm PITCH FLAT CABLE

RoHS  
Compliant

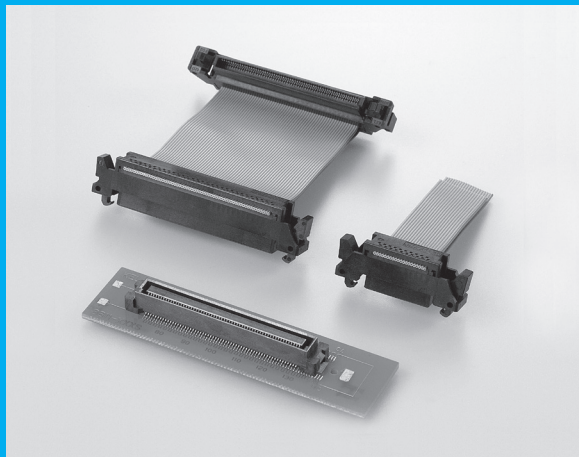

### FEATURES

- ▶ Highly reliable design with effective mating length of 1.4mm(0.055").
- ▶ IDC for 0.635mm(0.025") flat ribbon cable(#30 AWG).  
\*The connector is applicable to two overlaid flat cables.
- ▶ Connectors with the Eject-Lock mechanism, allowing one-handed insertion and release.
- ▶ Easy and secure connection can be achieved with KEL's original termination form.
- ▶ PCB side connector(Pulg, 863□E series) is able to mate with 8601 series.
- ▶ Coplanarity of 0.1mm(863□E).

### ORDER CODE

**8622** □ **N** - □ □ □ □

①

②

\*Please order in multiples of the quantity per package.

① **[Type]** Receptacle (Cable side connector), Ejector type **8622EN** : With strain relief **8622RN** : Without strain relief

② **[Number of contacts]** **040** : 40 pin **080** : 80 pin **100** : 100 pin **120** : 120 pin

### ORDER CODE

**863** □ **E** - □ □ □ □ **S** - □ - □

①

②

③

④

⑤

\*Please order in multiples of the quantity per package.

① **[Type]** **8630E** : Plug (PCB side connector) **8631E** : Plug, With lock protection shape (120 pins only)

② **[Number of contacts]** **040** : 40 pin **080** : 80 pin **100** : 100 pin **120** : 120 pin

③ **[Contact tail style]** **S** : Straight

④ **[Pick&Place cap]** **P** : With Pick&Place cap **Omit** : Without Pick&Place cap

⑤ **[Positioning boss]** **Omit** : With Boss **2** : Without Boss (8631E-120S-P-2 Only)

### SPECIFICATIONS

	Material and plating	Electrical Characteristics	
Insulator material	[8622□N] Glass-filled Nylon 66 (UL94V-0), Black	Current rating	0.5A per contact
	[863□E] Glass-filled LCP (UL94V-0), Black	Contact resistance	50mΩ max.
		Dielectric withstanding voltage	200V AC for 1minute
		Insulation resistance	100MΩ min.at 250V DC
Contact material	Copper alloy	Operating temperature	-40°C to +85°C
Contact plating	Gold over Nickel	Applicable cable	#30 AWG (7/0.102) Flat ribbon cable

### Mating Drawing

Unit : mm(inch)

PCB side connector(Plug, 8630E Series) is able to mate with 8622E(R) Series and 8601 Series.

#### ◆ Mating for Board to board connector

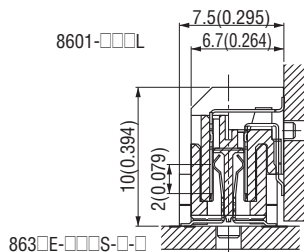

#### ◆ Mating for Board to cable connector

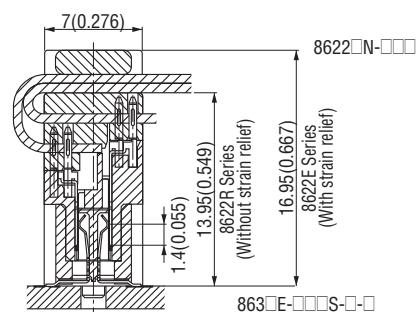

# 8622□N-□□□ (Receptacle, Cable side connector)

Unit : mm(inch)

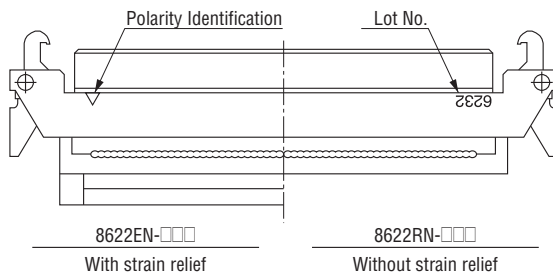
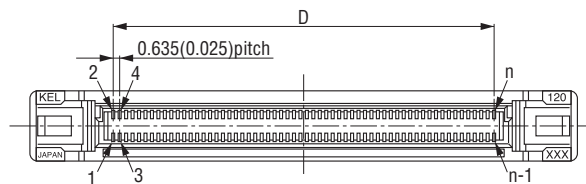
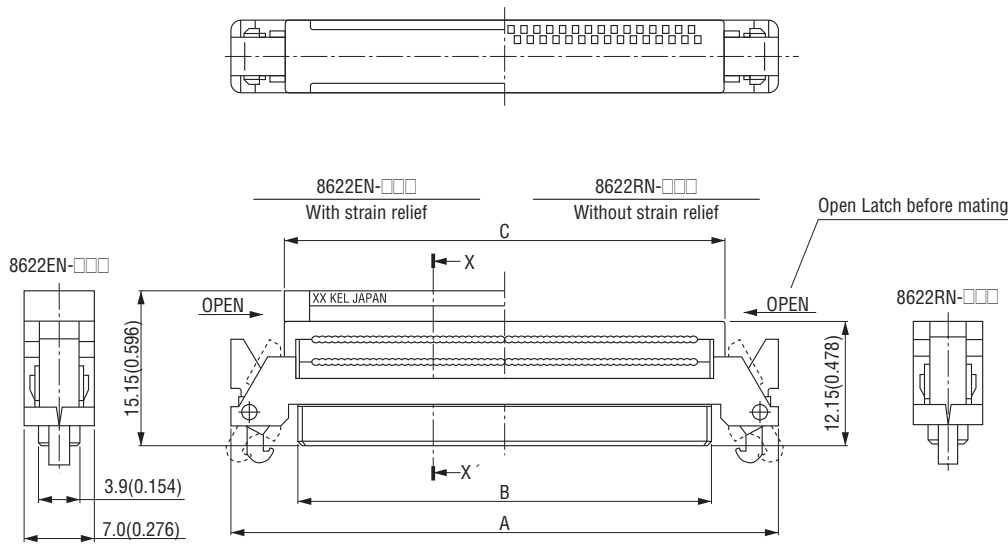

**X-X' Cross Section**

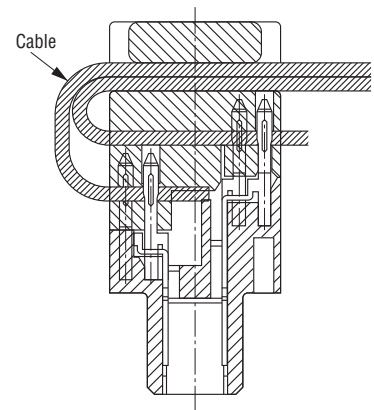

"n" is number of contacts.

Packaging style  
Pipe

► Product Table / Dimensions

No. of contacts	Part Number	A	B	C	D	No. of packaging
40	8622□N-040	28.95 (1.140)	15.75 (0.620)	18.35 (0.722)	12.065 (0.475)	17
80	8622□N-080	41.65 (1.640)	28.45 (1.120)	31.05 (1.222)	24.765 (0.975)	12
100	8622□N-100	48.00 (1.890)	34.80 (1.370)	37.40 (1.472)	31.115 (1.225)	10
120	8622□N-120	54.35 (2.140)	41.15 (1.620)	43.75 (1.722)	37.465 (1.475)	9

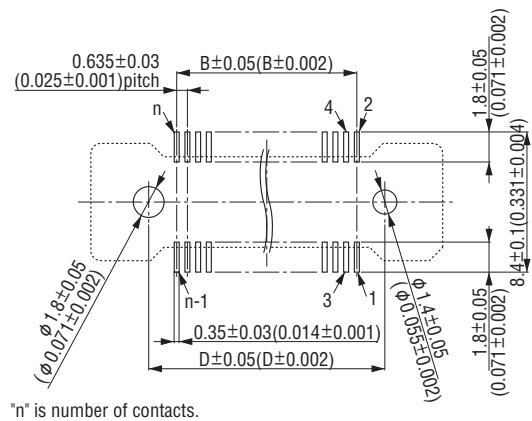
**▶ Printed Circuit Board Layout (Component Side View)**

\*n\* is number of contacts.

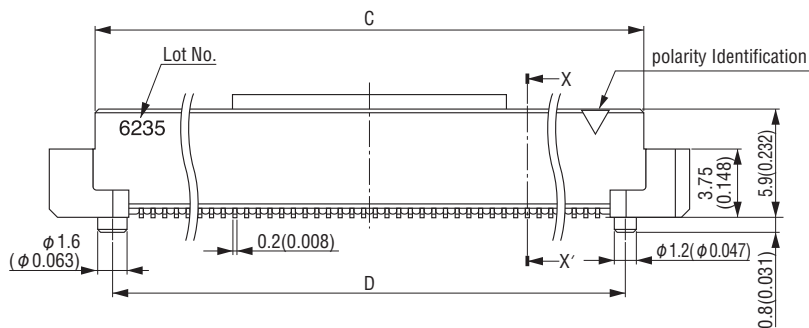
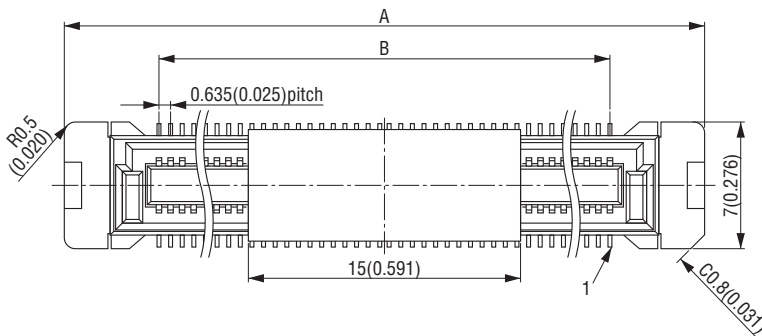
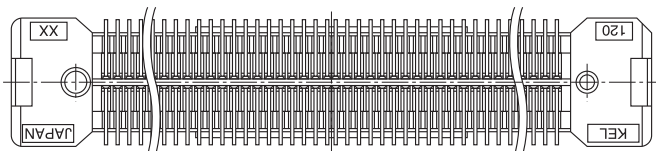
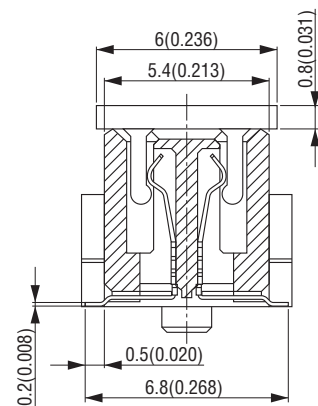
**X-X' Cross Section**

\*Figure of with pick&amp;place cap type is used.

Packaging style

Tray

**▶ Product Table / Dimensions**

No. of contacts	Part Number	A	B	C	D	No. of packaging
40	8630E-040S-□	22.35 (0.880)	12.065 (0.475)	17.35 (0.683)	15.35 (0.604)	60
80	8630E-080S-□	35.05 (1.380)	24.765 (0.975)	30.05 (1.183)	28.05 (1.104)	40
100	8630E-100S-□	41.40 (1.630)	31.115 (1.225)	36.40 (1.433)	34.40 (1.354)	30
120	8630E-120S-□	47.75 (1.880)	37.465 (1.475)	42.75 (1.683)	40.75 (1.604)	30



## CABLE ASSEMBLY

### ORDER CODE

**8622EN**-  -  -**A1**    

①      ②      ③      ④      ⑤

- ① **[Type]** **8622EN** : Receptacle (Cable side connector)  
With strain relief
- ② **[Number of contacts]** **040** : 40 pin **080** : 80 pin  
**100** : 100 pin **120** : 120 pin
- ③ **[Cable length (cm)]** **L** : Dimension (Example : 013=13cm)
- ④ **[Wiring code]** **A1AN, A1B1**
- ⑤ **[Quantity]** **(A)** : 1 to 9pcs **(B)** : 10 to 49pcs **(C)** : 50 to 99pcs  
**(D)** : 100 to 999pcs **(E)** : 1000pcs or more

### ORDER CODE

**8622RN**-  -  -**A1**    

①      ②      ③      ④      ⑤

- ① **[Type]** **8622RN** : Receptacle (Cable side connector)  
Without strain relief
- ② **[Number of contacts]** **040** : 40 pin **080** : 80 pin  
**100** : 100 pin **120** : 120 pin
- ③ **[Cable length (cm)]** **L** : Dimension (Example : 013=13cm)
- ④ **[Wiring code]** **A1AN, A1B1**
- ⑤ **[Quantity]** **(A)** : 1 to 9pcs **(B)** : 10 to 49pcs **(C)** : 50 to 99pcs  
**(D)** : 100 to 999pcs **(E)** : 1000pcs or more

#### ► Cable assembly

Unit : mm(inch)

Wiring Code: A1AN

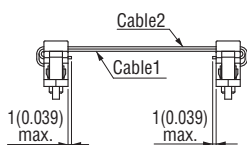
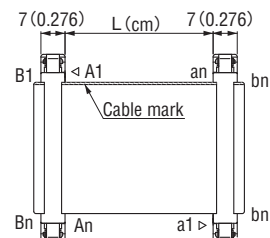

Wiring Diagram

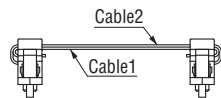
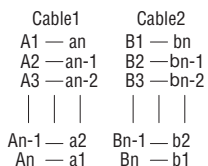

Component Side View

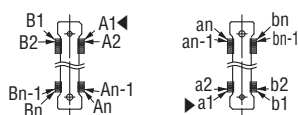

Wiring Code: A1B1

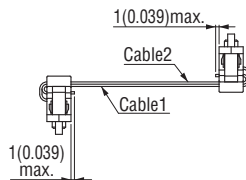
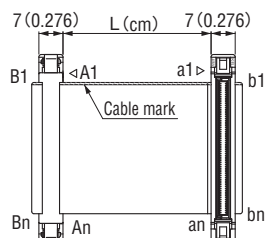

Wiring Diagram

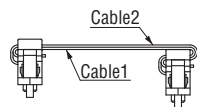
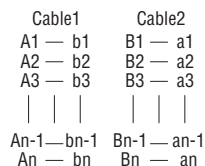

Component Side View

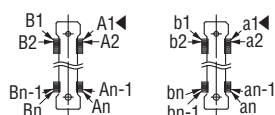

#### ► Cable assembly

Unit : mm(inch)

Wiring Code: A1AN

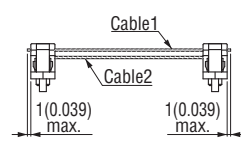
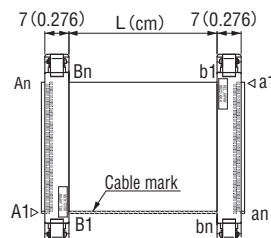

Wiring Diagram

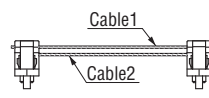
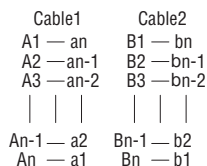

Component Side View

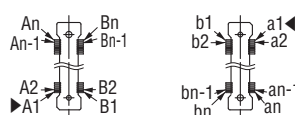

Wiring Code: A1B1

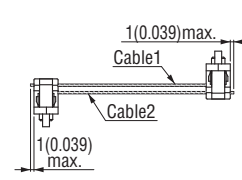
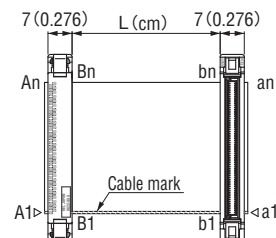

Wiring Diagram

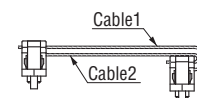
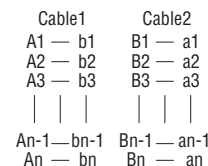

Component Side View

