



actual size

Oscillator JO75 · 2.8 V

- SMD Oscillator with Stop Function · 7.5 x 5.0 mm
- LVCMOS / HCMOS compatible output
- Low phase jitter, no PLL
- Seam sealed ceramic/metal package



RoHS compliant



Pb free



REACH compliant



Conflict mineral free

GENERAL DATA

TYPE		JO75 2.8 V
frequency range	STD & T1	0.50 ~ 50.0 MHz (30 pF max.)
		0.50 ~ 165.0 MHz (15 pF max.)
	T2	2.0 ~ 120.0 MHz (15 pF max.)
	T3*	2.0 ~ 120.0 MHz (15 pF max.)
frequency stability over all**		± 20 ppm ~ ± 100 ppm (table 1)
current consumption		see table 2
supply voltage V_{DC}		2.8 V ± 10 % (± 5 % for stab. C & D)
temperature	operating	-10 °C ~ +70 °C (STD)
		-40 °C ~ +85 °C (T1)
		-40 °C ~ +105 °C (T2)
		-40 °C ~ +125 °C (T3*)
	storage	-55 °C ~ +125 °C
output	rise & fall time	see table 3
	load max.	15 pF / 30 pF (≤ +85 °C and ≤ 50.0 MHz)
	current max.	8 mA / 4 mA (T2 & T3*)
	low level max.	0.1 x V_{DC} / 0.4 V for T2 & T3*
	high level min.	0.9 x V_{DC} / V_{DC} - 0.4V for T2 & T3*
output enable time max.		10 ms
output disable time max.		150 ns / 200 ns (T2 & T3*)
start-up time max.		10 ms
standby function		stop
standby current max.		10µA / 20µA (for T2 & T3*)
phase jitter 12 kHz ~ 20.0 MHz		< 1.0 ps RMS
symmetry at 0.5 x V_{DC}		45% ~ 55% typ. (40% ~ 60% max.)

TABLE 1: FREQUENCY STABILITY CODE

stability code		A	B	G	C	D
		± 100 ppm	± 50 ppm	± 30 ppm	± 25 ppm	± 20 ppm
-10 °C ~ +70 °C	STD		○	○	○	△
-40 °C ~ +85 °C	T1	○	○	○	□	
-40 °C ~ +105 °C	T2	○	○			
-40 °C ~ +125 °C	T3*	○	○			

○ available □ excludes aging △ if ≤ 50.0 MHz, excludes aging

* ask if available

** includes stability at 25 °C, operating temp. range, supply voltage change, shock and vibration, aging 1st year.

TABLE 2: CURRENT CONSUMPTION MAX.

Current at 15 pF load:		Current at 30 pF load:	
0.5 ~ 19.9 MHz	7 mA	0.5 ~ 19.9 MHz	12 mA
20.0 ~ 49.9 MHz	12 mA	20.0 ~ 50.0 MHz	25 mA
50.0 ~ 79.9 MHz	20 mA		
80.0 ~ 124.9 MHz	30 mA		
125.0 ~ 165.0 MHz	50 mA		

TABLE 3: RISE & FALL TIME MAX.

8 ns: 0.5 ~ 1.79 MHz	note: - specific data on request - rise time: 0.1 V_{DC} ~ 0.9 V_{DC} - fall time: 0.9 V_{DC} ~ 0.1 V_{DC}
6 ns: 1.8 ~ 49.99 MHz	
5 ns: 50.0 ~ 79.99 MHz	
4 ns: 80.0 ~ 124.99 MHz	
3 ns: 125.0 ~ 165.00 MHz	

DIMENSIONS

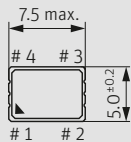

top view

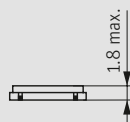

side view

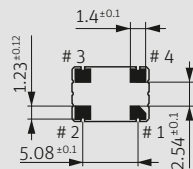

bottom view

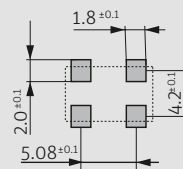

pad layout

1: e/d
2: ground
3: output
4: V_{DC}

pin connection

in mm

ORDER INFORMATION

0	frequency	type	frequency stability code	supply voltage code	output load code	option
Oscillator	0.5 ~ 165.0 MHz	JO75	see table 1	2.8 = 2.8 V	1 = 15 pF 2 = 30 pF	blank = -10 °C ~ +70 °C T1 = -40 °C ~ +85 °C T2 = -40 °C ~ +105 °C T3 = -40 °C ~ +125 °C

Example: 0 20.0-JO75-B-2.8-1 (Suffix LF = RoHS compliant / Pb free)

Oscillator J075 · 2.8 V · Stop Function

TAPING SPECIFICATION

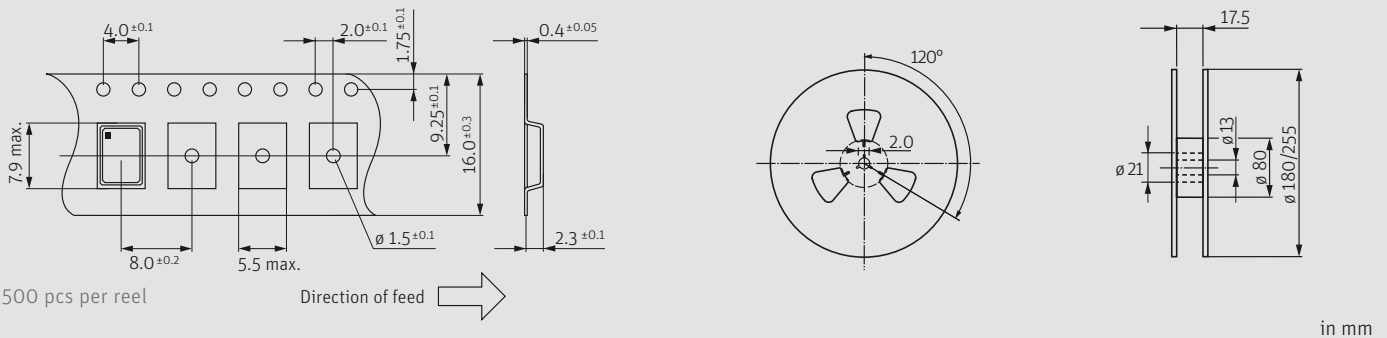

ENABLE / DISABLE FUNCTION

pin #1 (e/d control)	pin #3 (output)
open	active
high "1" ($V_{IH} \geq 0.8 V_{DC}$)	active
low "0" ($V_{IL} \leq 0.2 V_{DC}$)	high impedance

stop function:

- oscillator stops
- output high impedance

MARKING

frequency

company stability code / voltage data code

data code: A ~ M: Jan. - Dec.

7: 2017 8: 2018 9: 2019 0: 2020 1: 2021 2: 2022

Jan.	Febr.	Mar.	Apr.	May	June
A	B	C	D	E	F
July	Aug.	Sept.	Oct.	Nov.	Dec.
G	H	J	K	L	M

REFLOW SOLDERING PROFILE

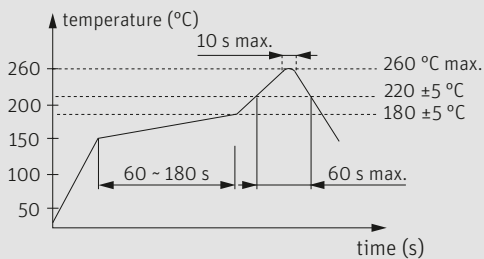

note: parts are also suitable for soldering systems with lead (Pb) content

PACKAGING NOTE

- standard packing unit is 500 pieces per reel
- non-multiple packing units are only supplied taped / bulk