

**50mil (1.27mm) PITCH 2 PIECE CONNECTOR
IDC Connector for Discrete Wire Cable (#28 AWG)**

8927E SERIES

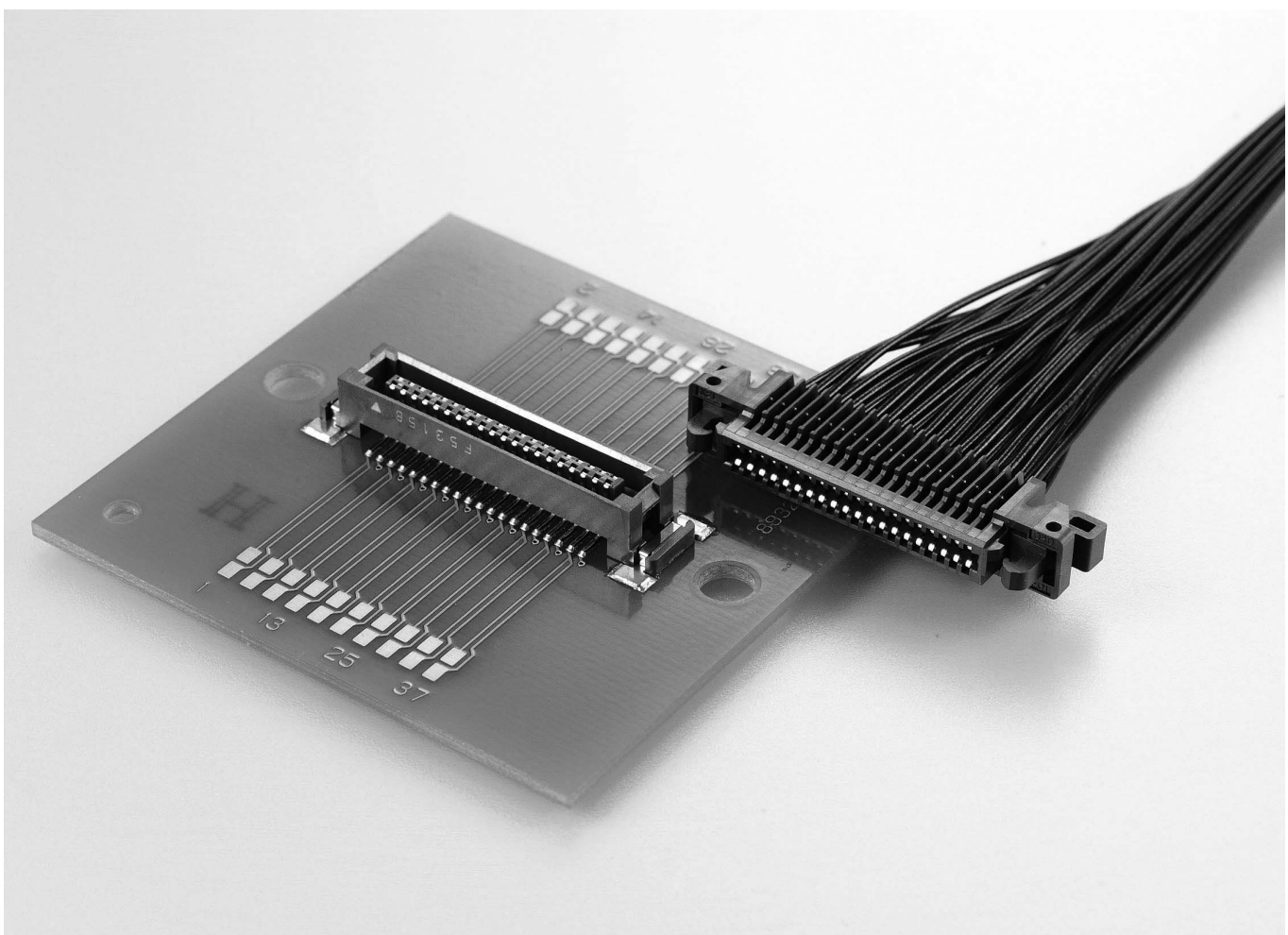

Distributed by:

B.C.E. S.r.l.

Via Regina Pacis, 54/c - I 41049 Sassuolo - (MO)

Tel: (+39) 0536 811616 - **Fax:** (+39) 0536 811500

E-mail.: bce@bce.it • **Home Page :** www.bce.it

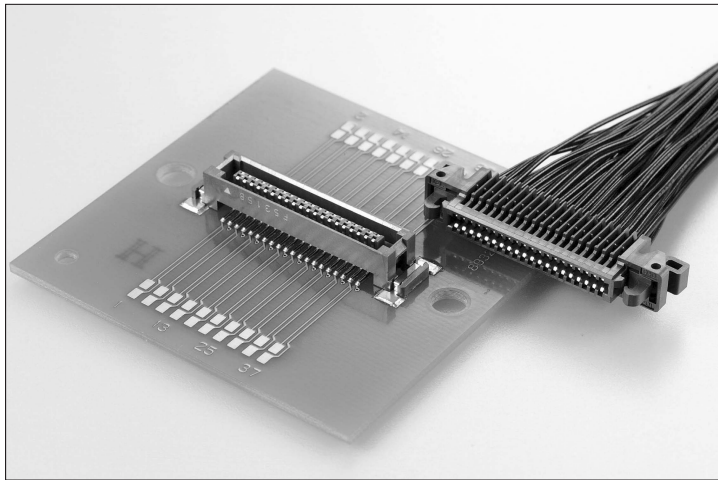

FEATURES

- 1.27mm pitch Board to Cable connector
- Designed for discrete wire cable (#28 AWG)
- One-touch locking ejector system
- Two sizes : 20 and 40 pins
- RoHS compliance

SPECIFICATIONS

- Insulator material (Receptacle / 8927E) : Glass-filled Nylon 66(UL94V-0), Brown
- Insulator material (Plug / 8932E) : Glass-filled PPS (UL94V-0), Natural (Brown)
- Lock material : Glass-filled Nylon 66 (UL94V-0), Brown
- Contact material : Copper alloy
- Contact plating : Contact area ; Gold over Nickel
Terminal area ; Gold over Nickel
IDC area ; Gold over Nickel
- SMT retention clip material : Copper alloy
- SMT retention clip plating : Tin copper over Nickel
- Pick&Place cap material : Glass-filled Nylon 46 (UL94V-0), Natural (White)
- Current rating : 1A per contact
- Contact resistance : 40mΩ max.
- Dielectric withstanding voltage : 300V AC for 1minute
- Insulation resistance : 1000MΩ min. at 250V DC
- Recommended cable : #28 AWG (7/0.127), 1.27mm pitch discrete wire cable
- Operating temperature : -40°C to +85°C

ORDER CODE

8927E - [] [] []

- Number of contacts
020 : 20 pin
040 : 40 pin
- Series name
8927E : Receptacle (Cable Side Connector)
Ejector type

ORDER CODE

8932E - [] [] [] **MS-B-F** []

- Contact tail style
MS : Straight, SMT
- Connector height
B : 6mm
- F : RoHS compliance
- Omit : Embossed tape packaging (With Pick&Place cap)
- Number of contacts
020 : 20 pin
040 : 40 pin
- Series name
8932E : Plug (PCB Side Connector)

8927E-□□□(Receptacle, IDC)

Unit:mm(inch)

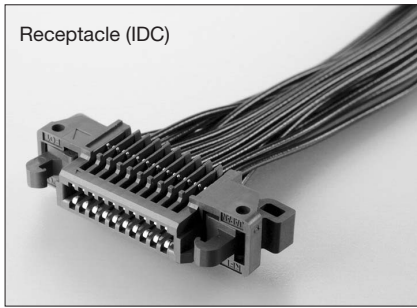

Receptacle (IDC)

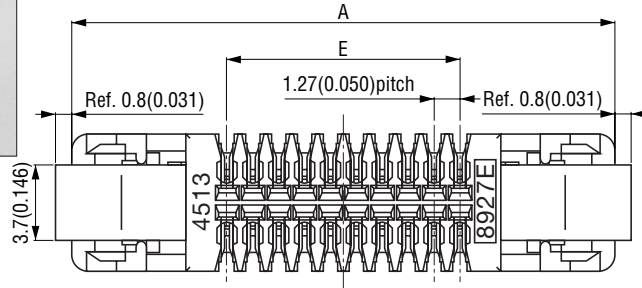

X-X' Cross Section

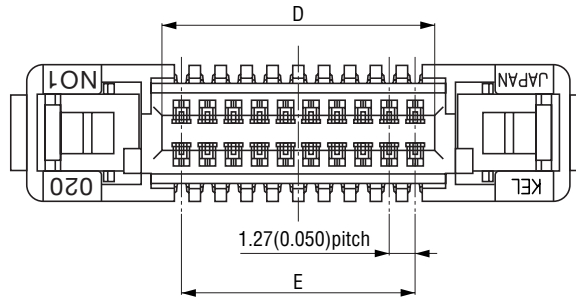
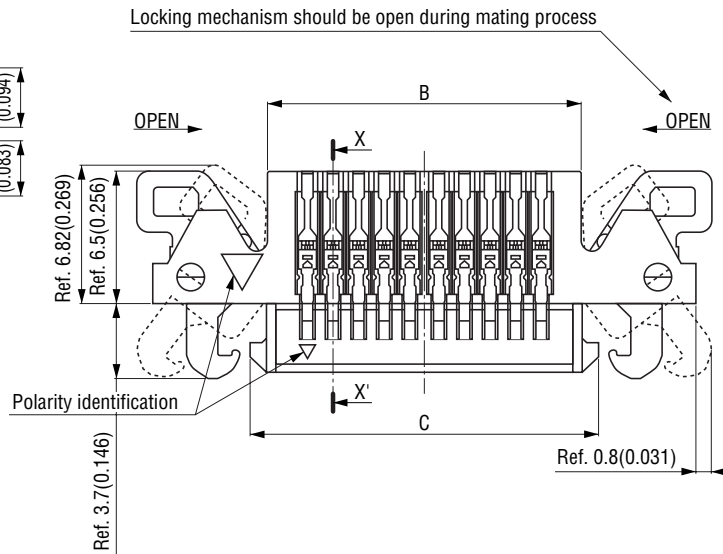
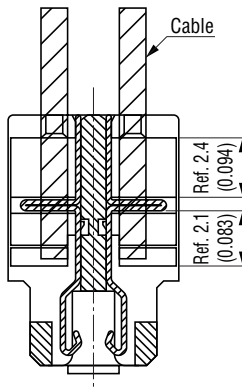

Packaging style
Pipe

■ Product Table / Dimensions

No. of contacts	Part Number	A	B	C	D	E	Number of packaging
20	8927E-020	26.43 (1.041)	15.43 (0.607)	17.03 (0.670)	13.43 (0.529)	11.43 (0.450)	18
40	8927E-040	39.13 (1.541)	28.13 (1.107)	29.73 (1.170)	26.13 (1.029)	24.13 (0.950)	12

8932E-□□□MS-B-F□ (Plug)

Unit:mm(inch)

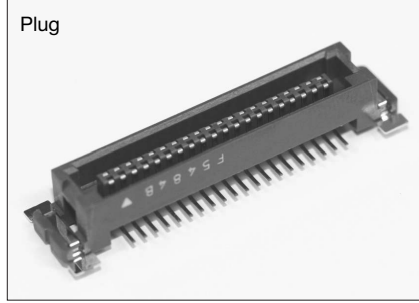
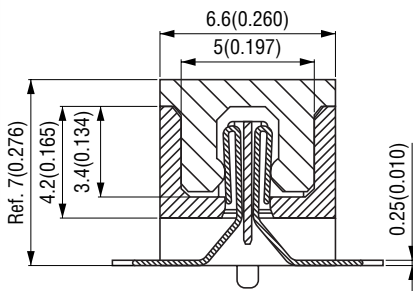
X-X' Cross Section

Polarity identification

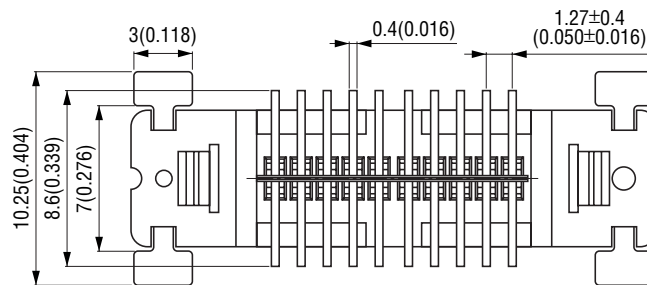
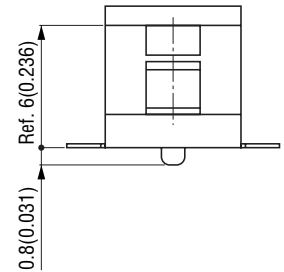
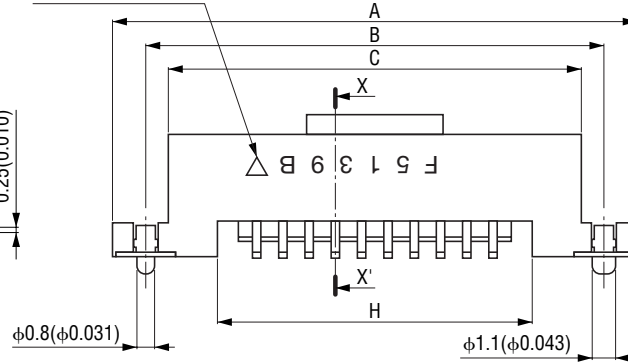
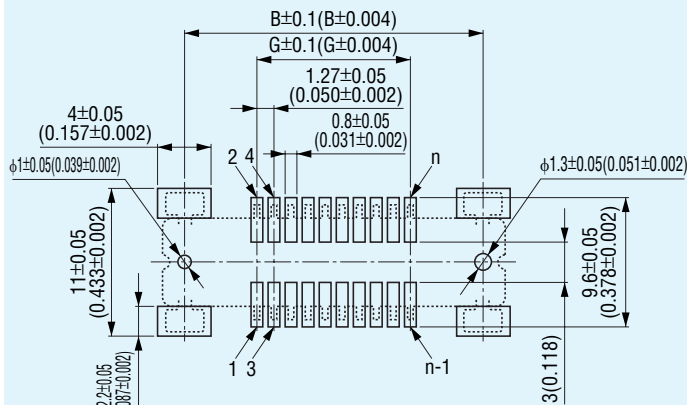
Printed Circuit Board Layout (Component Side View)

"n" is number of contacts.

 Packaging style
Embossed tape

Product Table / Dimensions

No. of contacts	Part Number	A	B	C	D
20	8932E-020MS-B-F□	25.43 (1.001)	22.23 (0.875)	20.03 (0.789)	17.43 (0.686)
40	8932E-040MS-B-F□	38.13 (1.501)	34.93 (1.375)	32.73 (1.289)	30.13 (1.186)

No. of contacts	Part Number	E	F	G	H	Number of packaging
20	8932E-020MS-B-F□	15.23 (0.600)	13.13 (0.517)	11.43 (0.450)	15.23 (0.600)	500
40	8932E-040MS-B-F□	27.93 (1.100)	25.83 (1.017)	24.13 (0.950)	27.93 (1.100)	500

Specifications and dimensions are subject to change without notice.