



USB Connector

1. Specifications _____ 250

2. How to Order _____ 251

3. Item List _____ 252

USB for Panel

USB Molded with Cable

USB for Field Installable

USB for Waterproof to Non-Waterproof



SPECIFICATIONS

USB SERIES

No.	SPECIFICATIONS	STANDARD VALUE
01	Manufacturer Identifications	USB A Type, USB B Type
02	Description	Panel Mount, Molded with Cable, Field Installable
03	Current Rating	1.5A
04	Speed	480 Mbps
05	Material	Contacts: Copper Alloy, Gold Plated Connector Body: PBT UL94V-0
06	Temperature Range	-20°C to +80°C
07	Waterproof Rating	IP67, IP68
08	Contact Resistance	≤ 30 mΩ Max
09	Insulation Resistance	≥ 1000 MΩ Min.
10	Breakdown Voltage	≥ AC 500V / 1 Minute

USB

HOW TO ORDER

USB CONNECTOR

LTW 1 - 2 3 4 5 6 - 7 8 9 10 11

LT : Liang Tei

W : Waterproof

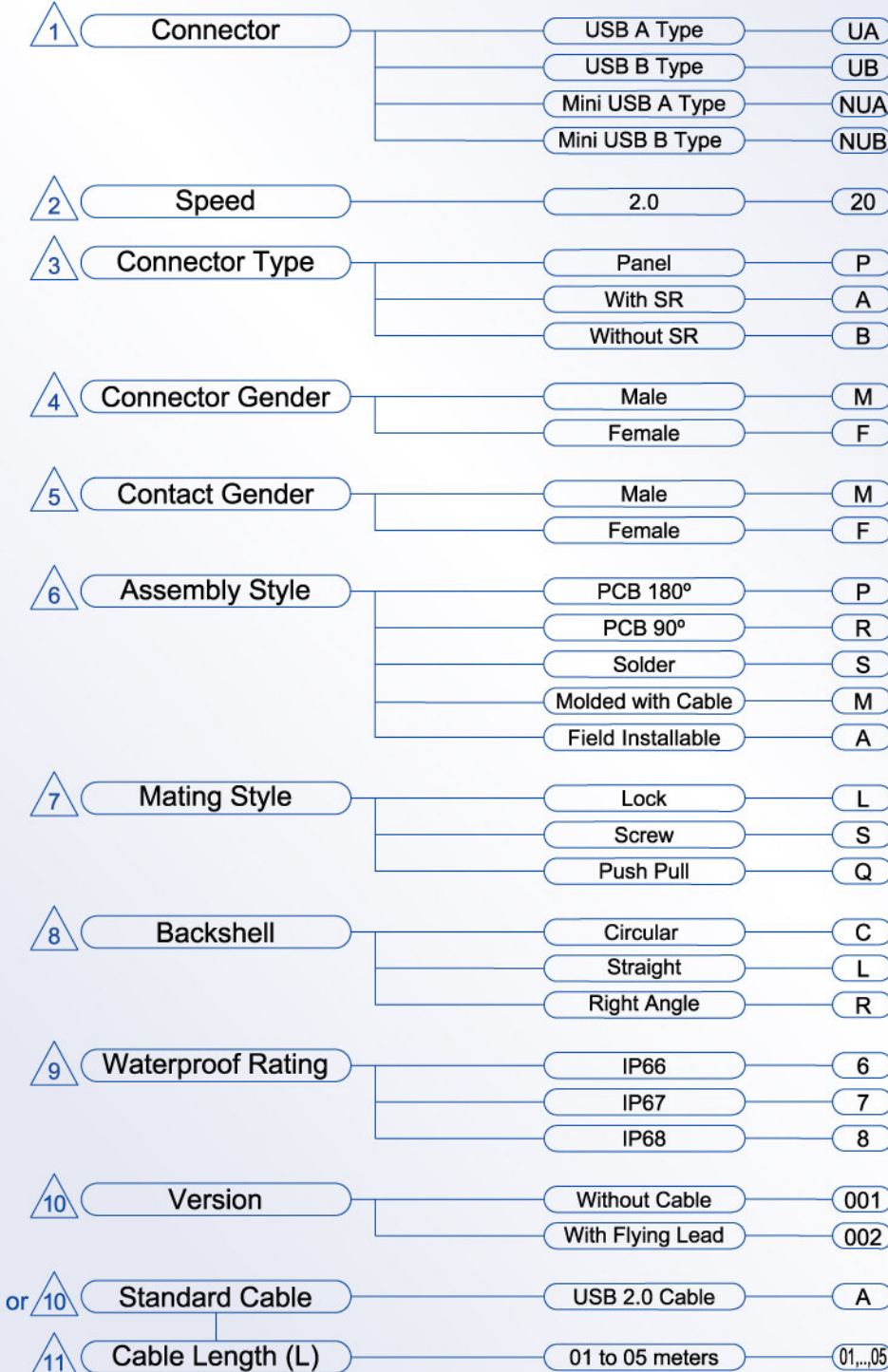
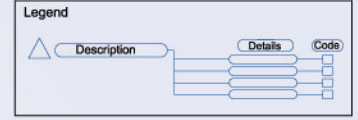

USB

UNIVERSAL SERIAL BUS

Item Number	Number of Contacts	DESCRIPTION	Page	Old Item Number
Panel				
LTWUA-20PMFP-LC7	USB 2.0	Panel Mount. USB A Type. PCB 180°. Circular Backshell, Lock Type.	253	New Product
LTWUB-20PMFP-LC7	USB 2.0	Panel Mount. USB B Type. PCB 180°. Circular Backshell, Lock Type.	254	New Product
LTWUA-20PMFP-SC8	USB 2.0	Panel Mount. USB A Type. PCB 180°. Circular Backshell, Screw Type.	255	LTW2.0USB-APFPSX
LTWUB-20PMFP-SC8	USB 2.0	Panel Mount. USB B Type. PCB 180°. Circular Backshell, Screw Type.	256	LTW2.0USB-BPFPSX
Molded with Cable				
LTWUA-20AFMM-LR7A	USB 2.0	With SR. USB A Type. Female Connector. Right, Lock Type.	257	New Product
LTWUB-20AFMM-LR7A	USB 2.0	With SR. USB B Type. Female Connector. Right, Lock Type.	258	New Product
LTWUA-20BFMM-SL7A	USB 2.0	Without SR. USB A Type. Female Connector. Straight, Screw Type.	259	LTWUSB-ABMMSIM
LTWUB-20BFMM-SL7A	USB 2.0	Without SR. USB B Type. Female Connector. Straight, Screw Type.	260	New Product
LTWUA-20AMFM-SL7A	USB 2.0	With SR. USB A Type. Male Connector. Straight, Screw Type.	261	LTWUSB-ABFMSIM
LTWUB-20AMFM-SL7A	USB 2.0	With SR. USB B Type. Male Connector. Straight, Screw Type.	262	New Product
Field Installable				
LTWUA-20BMFA-SL8001	USB 2.0	Without SR. USB A Type. Male Connector. Straight, Screw Type.	263	New Product
LTWUB-20BMFA-SL8001	USB 2.0	Without SR. USB B Type. Male Connector. Straight, Screw Type.	264	New Product
Waterproof to Non-Waterproof				
LTWU 1-20 3 4 5-6 7A 9	USB 2.0	With or Without SR. USB A or B Type. Jack or Plug Connector. Straight.	265	New Product

USB

USB A Lock Type: Unmated Waterproof Panel Mount (Male)

LTWUA-20PMFP-LC7 

New Product



Specifications

DESCRIPTION	DETAILS	CODE
1 Connector	USB A Type	UA
2 Speed	2.0	20
3 Connector Type	Panel	P
4 Connector Gender	Male	M
5 Contact Gender	Female	F
6 Assembly Style	PCB 180°	P
7 Mating Style	Lock	L
8 Backshell	Circular	C
9 Waterproof Rating	IP67	7
 Version	Without Flying Lead	001
	With Flying Lead	002

Material

Pin : Copper Alloy, 30u" Gold Plated
 Connector Body : PBT UL94V-0
 Temperature Range : -20°C to 80°C

Recommended Panel Cut-Out

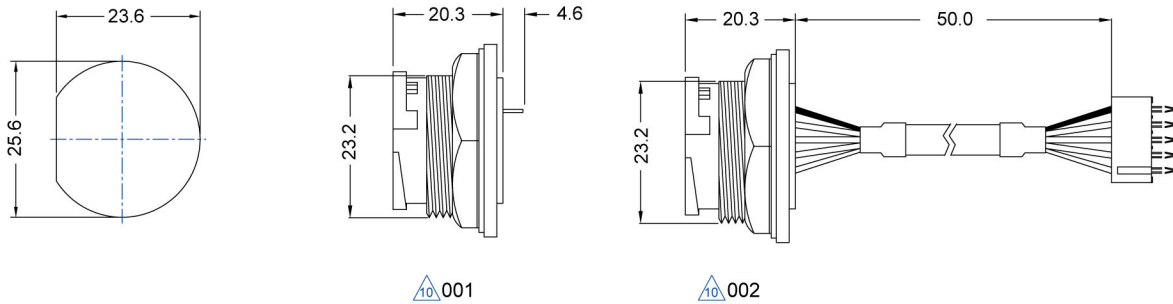

Pin Configuration and PCB Layout

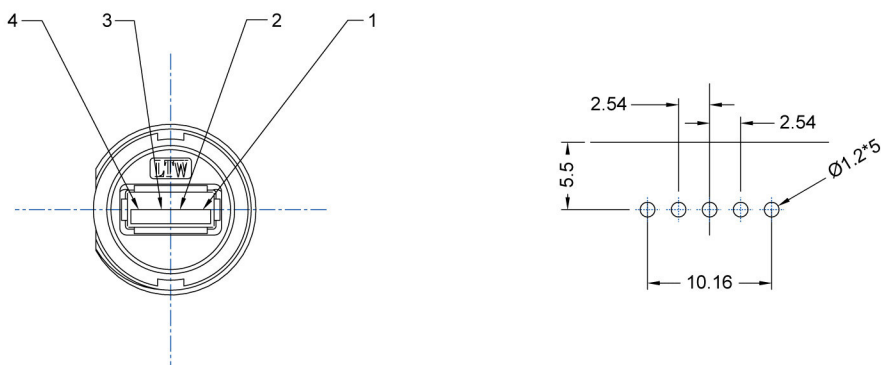

Mating Parts



LTWUA-20AFMM-LR7A 

See Item List

USB

USB B Lock Type: Unmated Waterproof Panel Mount (Male)

LTWUB-20PMFP-LC7 

New Product



Specifications

DESCRIPTION	DETAILS	CODE
1 Connector	USB B Type	UB
2 Speed	2.0	20
3 Connector Type	Panel	P
4 Connector Gender	Male	M
5 Contact Gender	Female	F
6 Assembly Style	PCB 180°	P
7 Mating Style	Lock	L
8 Backshell	Circular	C
9 Waterproof Rating	IP67	7
 Version	Without Flying Lead	001
	With Flying Lead	002

Material

Pin : Copper Alloy, 30u" Gold Plated
 Connector Body : PBT UL94V-0
 Temperature Range : -20°C to 80°C

Recommended Panel Cut-Out

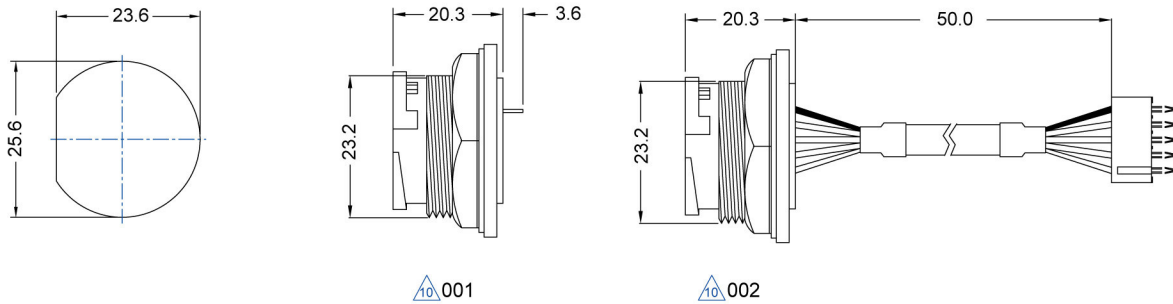

Pin Configuration and PCB Layout

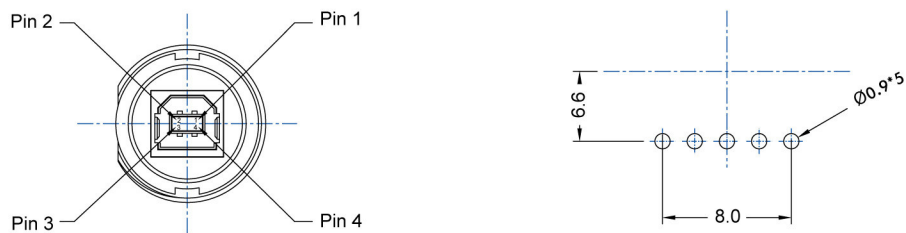

Mating Parts



LTWUB-20AFMM-LR7A 

See Item List

USB A Screw Type: Unmated Waterproof Panel Mount (Male)

LTWUA-20PMFP-SC8

Old Part Number: LTW2.0USB-APFPSX



Specifications

DESCRIPTION	DETAILS	CODE
1 Connector	USB A Type	UA
2 Speed	2.0	20
3 Connector Type	Panel	P
4 Connector Gender	Male	M
5 Contact Gender	Female	F
6 Assembly Style	PCB 180°	P
7 Mating Style	Screw	S
8 Backshell	Circular	C
9 Waterproof Rating	IP68	8
 Version	Without Flying Lead	001
	With Flying Lead	002

Material

Pin : Copper Alloy, 30u" Gold Plated
 Connector Body : PBT UL 94V-0
 Temperature Range : -20°C to 80°C

Recommended Panel Cut-Out

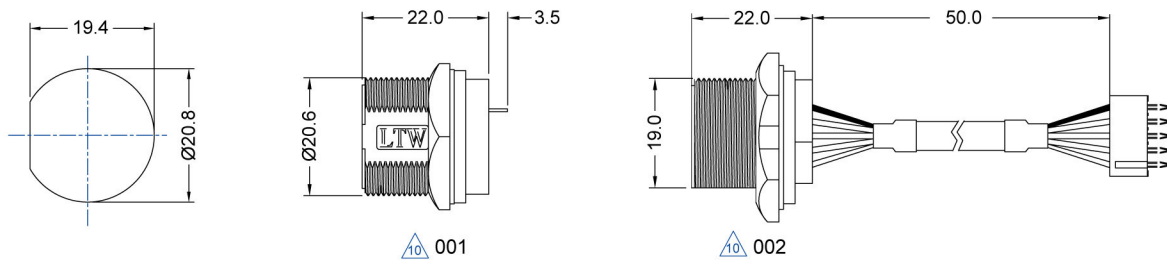

Pin Configuration and PCB Layout

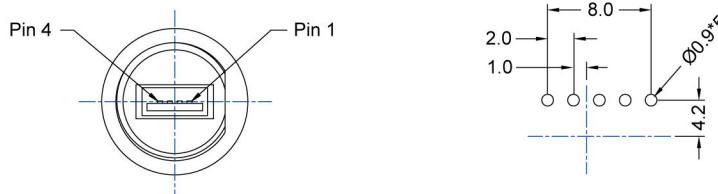

Mating Parts



LTWUA-20BFMM-SL7A 

See Item List

Accessory



See Item List

USB

USB B Screw Type: Unmated Waterproof Panel Mount (Male)

LTWUB-20PMFP-SC8

Old Part Number: LTW2.0USB-BPFP SX



Specifications

DESCRIPTION	DETAILS	CODE
1 Connector	USB B Type	UB
2 Speed	2.0	20
3 Connector Type	Panel	P
4 Connector Gender	Male	M
5 Contact Gender	Female	F
6 Assembly Style	PCB 180°	P
7 Mating Style	Screw	S
8 Backshell	Circular	C
9 Waterproof Rating	IP68	8
 Version	Without Flying Lead	001
	With Flying Lead	002

Material

Pin : Copper Alloy, 30u" Gold Plated
 Connector Body : PBT UL 94V-0
 Temperature Range : -20°C to 80°C

Recommended Panel Cut-Out

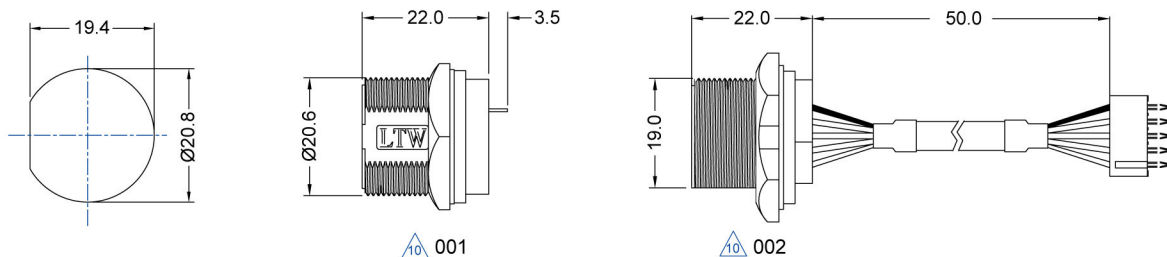

Pin Configuration and PCB Layout

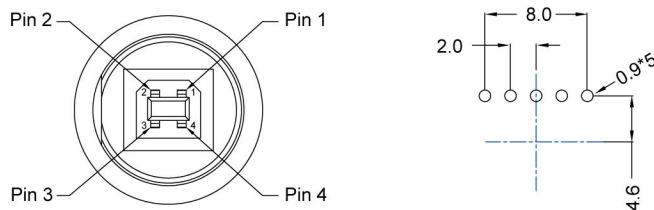

Mating Parts



LTWUB-20BFMM-SL7A 

See Item List

Accessory



See Item List

USB A Lock Type: Molded With Cable (Female)

LTWUA-20AFMM-LR7A 

New Product



Specifications

DESCRIPTION	DETAILS	CODE
1 Connector	USB A	UA
2 Speed	2.0	20
3 Connector Type	With SR	A
4 Connector Gender	Female	F
5 Contact Gender	Male	M
6 Assembly Style	Molded with Cable	M
7 Mating Style	Lock	L
8 Backshell	Right Angle	R
9 Waterproof Rating	IP67	7
10 Standard Cable	USB 2.0	A
 Cable Length (L)	1 to 5 meters	01,...,05

SR= Strain Relief

Material

Pin : Copper Alloy, 30u" Gold Plated
 Connector Body : PBT UL 94V-0
 Cable Temperature : -20°C to 80°C

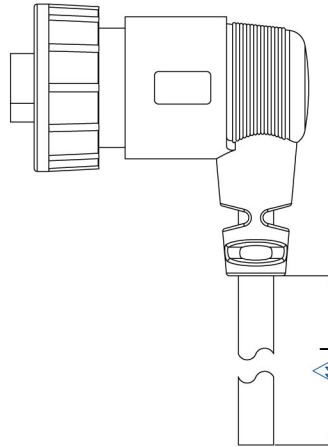

Pin Configuration

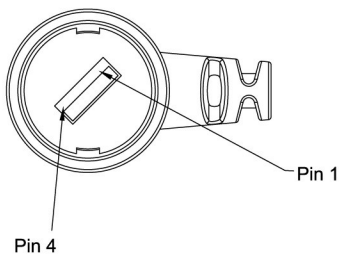

LTW Standard Cable:

Part no.	Type	Color	OD(mm)
WCA0365UV01	PVC	Black	5.0

Note: Please see Cable Index for further details

Mating Parts



LTWUA-20PMFP-LC7 

See Item List

USB

USB B Lock Type: Molded With Cable (Female)

LTWUB-20AFMM-LR7A 

New Product



Specifications

DESCRIPTION	DETAILS	CODE
1 Connector	USB B	UB
2 Speed	2.0	20
3 Connector Type	With SR	A
4 Connector Gender	Female	F
5 Contact Gender	Male	M
6 Assembly Style	Molded with Cable	M
7 Mating Style	Lock	L
8 Backshell	Right Angle	R
9 Waterproof Rating	IP67	7
10 Standard Cable	USB 2.0	A
 Cable Length (L)	1 to 5 meters	01,...,05

SR= Strain Relief

Material

Pin : Copper Alloy, 30u" Gold Plated
 Connector Body : PBT UL 94V-0
 Cable Temperature : -20°C to 80°C

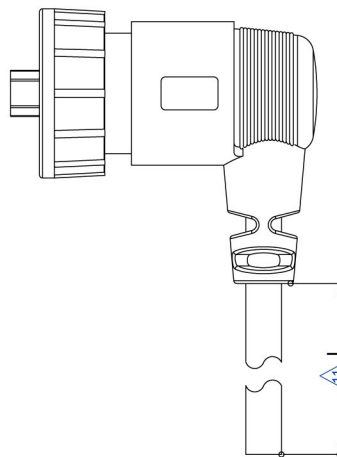

Pin Configuration

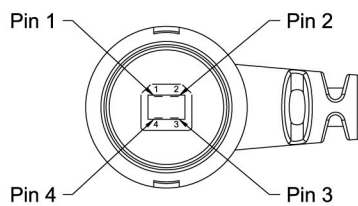

LTW Standard Cable:

Part no.	Type	Color	OD(mm)
WCA0365UV01	PVC	Black	5.0

Note: Please see Cable Index for further details

Mating Parts



LTWUB-20PMFP-LC7 

See Item List

USB A Screw Type: Molded With Cable (Female)

LTWUA-20BFMM-SL7A ¹¹

Old Part Number: LTWUSB-ABMMSIM



Specifications

DESCRIPTION	DETAILS	CODE
1 Connector	USB A	UA
2 Speed	2.0	20
3 Connector Type	Without SR	B
4 Connector Gender	Female	F
5 Contact Gender	Male	M
6 Assembly Style	Molded with Cable	M
7 Mating Style	Screw	S
8 Backshell	Straight	L
9 Waterproof Rating	IP67	7
10 Standard Cable	USB 2.0	A
¹¹ Cable Length (L)	1 to 5 meters	01,...,05

Material

Pin : Copper Alloy, 30u" Gold Plated
 Connector Body : PBT UL94V-0
 Temperature Range : -20°C to 80°C

SR= Strain Relief

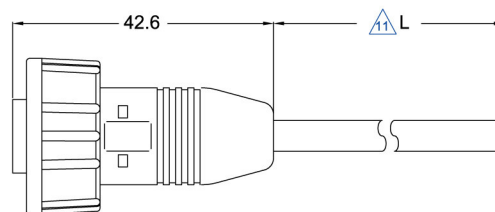

Pin Configuration

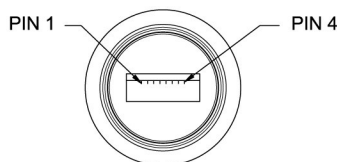

LTW Standard Cable:

Part no.	Type	Color	OD(mm)
WCA0365UV01	PVC	Black	5.0

Note: Please see Cable Index for further details

Mating Parts



LTWUA-20PMFP-SC8 ¹⁰

See Item List



LTWUA-20AMFM-SL7A ¹¹

See Item List



LTWUA-20BMFA-SL8001

See Item List

Accessory



See Item List

USB B Screw Type: Molded With Cable (Female)

LTWUB-20BFMM-SL7A ¹¹

New Product



Specifications

DESCRIPTION	DETAILS	CODE
1 Connector	USB B	UB
2 Speed	2.0	20
3 Connector Type	Without SR	B
4 Connector Gender	Female	F
5 Contact Gender	Male	M
6 Assembly Style	Molded with Cable	M
7 Mating Style	Screw	S
8 Backshell	Straight	L
9 Waterproof Rating	IP67	7
10 Standard Cable	USB 2.0	A
¹¹ Cable Length (L)	1 to 5 meters	01,...,05

Material

Pin : Copper Alloy, 30u" Gold Plated

Connector Body : PBT UL94V-0

Temperature Range : -20°C to 80°C

SR= Strain Relief

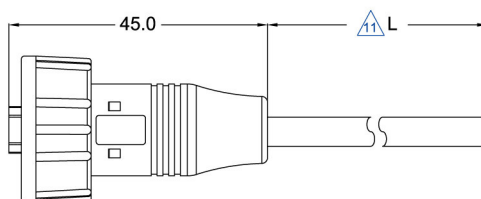

Pin Configuration

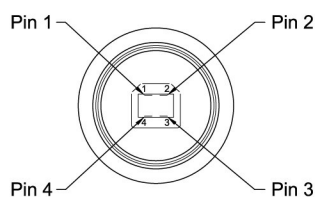

LTW Standard Cable:

Part no.	Type	Color	OD(mm)
WCA0365UV01	PVC	Black	5.0

Note: Please see Cable Index for further details

Mating Parts



LTWUB-20PMFP-SC8 ¹⁰

See Item List



LTWUB-20AMFM-SL7A ¹¹

See Item List



LTWUB-20BMFA-SL8001

See Item List

Accessory



See Item List

USB A Screw Type: Molded With Cable (Male)

LTWUA-20AMFM-SL7A

Old Part Number: LTWUSB-ABFMSIM



Specifications

DESCRIPTION	DETAILS	CODE
1 Connector	USB A	UA
2 Speed	2.0	20
3 Connector Type	With SR	A
4 Connector Gender	Male	M
5 Contact Gender	Female	F
6 Assembly Style	Molded with Cable	M
7 Mating Style	Screw	S
8 Backshell	Straight	L
9 Waterproof Rating	IP67	7
10 Standard Cable	USB 2.0	A
 Cable Length (L)	1 to 5 meters	01,...,05

SR= Strain Relief

Material

Pin : Copper Alloy, 30u" Gold Plated

Connector Body : PBT UL94V-0

Temperature Range : -20°C to 80°C

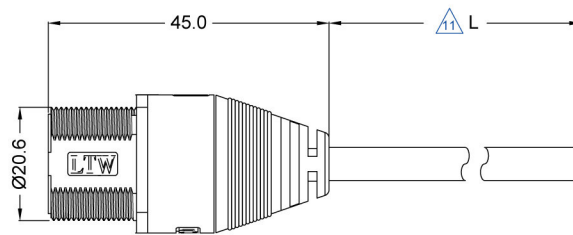

Pin Configuration

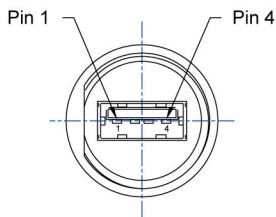

LTW Standard Cable:

No. of Pins	Part no.	Type	Color	OD(mm)
04	WCA0365UV01	PVC	Black	5.0

Note: Please see Cable Index for further details

Mating Parts



LTWUA-20BFMM-SL7A 

See Item List

Accessory



See Item List

USB B Screw Type: Molded With Cable (Male)

LTWUB-20AMFM-SL7A 

New Product



Specifications

DESCRIPTION	DETAILS	CODE
1 Connector	USB B	UB
2 Speed	2.0	20
3 Connector Type	With SR	A
4 Connector Gender	Male	M
5 Contact Gender	Female	F
6 Assembly Style	Molded with Cable	M
7 Mating Style	Screw	S
8 Backshell	Straight	L
9 Waterproof Rating	IP67	7
10 Standard Cable	USB 2.0	A
 Cable Length (L)	1 to 5 meters	01,...,05

SR= Strain Relief

Material

Pin : Copper Alloy, 30u" Gold Plated
 Connector Body : PBT UL94V-0
 Temperature Range : -20°C to 80°C

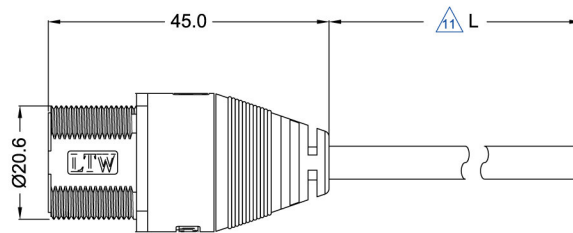

Pin Configuration

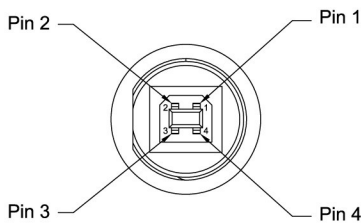

LTW Standard Cable:

No. of Pins	Part no.	Type	Color	OD(mm)
04	WCA0365UV01	PVC	Black	5.0

Note: Please see Cable Index for further details

Mating Parts



LTWUB-20BFMM-SL7A 

See Item List

Accessory



See Item List

USB A Screw Type: Field Installable (Male)

LTWUA-20BMFA-SL8001

New Product



Specifications

DESCRIPTION	DETAILS	CODE
1 Connector	USB A	UA
2 Speed	2.0	20
3 Connector Type	Without SR	B
4 Connector Gender	Male	M
5 Contact Gender	Female	F
6 Assembly Style	Field Installable	A
7 Mating Style	Screw	S
8 Backshell	Straight	L
9 Waterproof Rating	IP68	8
10 Version	Without Cable	001

SR= Strain Relief

Material

Pin : Copper Alloy, 30u" Gold Plated

Connector Body : PBT UL 94V-0

Temperature Range : -20°C to 80°C

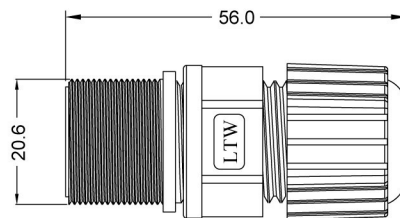

Seals for Cable OD: Ø5.0mm-Ø10.8mm

USB

Pin Configuration

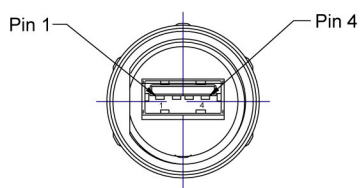

Mating Parts



LTWUA-20BFMM-SL7A

See Item List

Accessory



See Item List

USB B Screw Type: Field Installable (Male)

LTWUB-20BMFA-SL8001

New Product



Specifications

DESCRIPTION	DETAILS	CODE
1 Connector	USB B	UB
2 Speed	2.0	20
3 Connector Type	Without SR	B
4 Connector Gender	Male	M
5 Contact Gender	Female	F
6 Assembly Style	Field Installable	A
7 Mating Style	Screw	S
8 Backshell	Straight	L
9 Waterproof Rating	IP68	8
10 Version	Without Cable	001

SR= Strain Relief

Material

Pin : Copper Alloy, 30u" Gold Plated

Connector Body : PBT UL 94V-0

Temperature Range : -20°C to 80°C

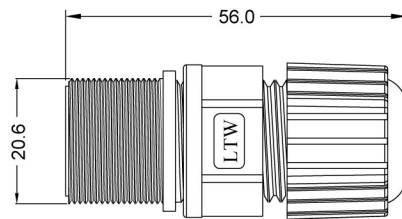

Seals for Cable OD: Ø5.0mm~Ø10.8mm

Pin Configuration

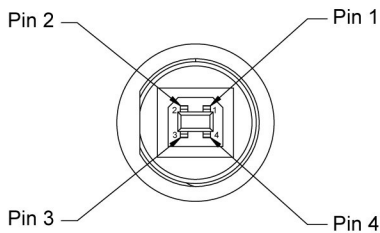

Mating Parts



LTWUB-20BFMM-SL7A 

See Item List

Accessory



See Item List

Waterproof USB to Non-Waterproof USB: Molded with Cable

LTW 1 -20 3 4 5 - 6 7A 9

New Product

Specifications



DESCRIPTION	DETAILS	CODE
1 Waterproof Connector	USB A Type	UA
	USB B Type	UB
	Mini USB A Type	NUA
	Mini USB B Type	NUB
2 Speed	2.0	20
3 Connector Style	With SR or Without SR	A or B
4 Connector Gender	Male or Female	M or F
5 Contact Gender	Male or Female	M or F
6 Non-Waterproof Connector	USB A Type	A
	USB B Type	B
	Mini USB A Type	C
7 Waterproof Rating	IP67	7
8 Standard Cable	USB 2.0	A
9 Cable Length (L)	1 to 5 meters	01,...,05

Material

Waterproof Connector Body : PBT UL94V-0

Temperature Range : -20°C to 80°C

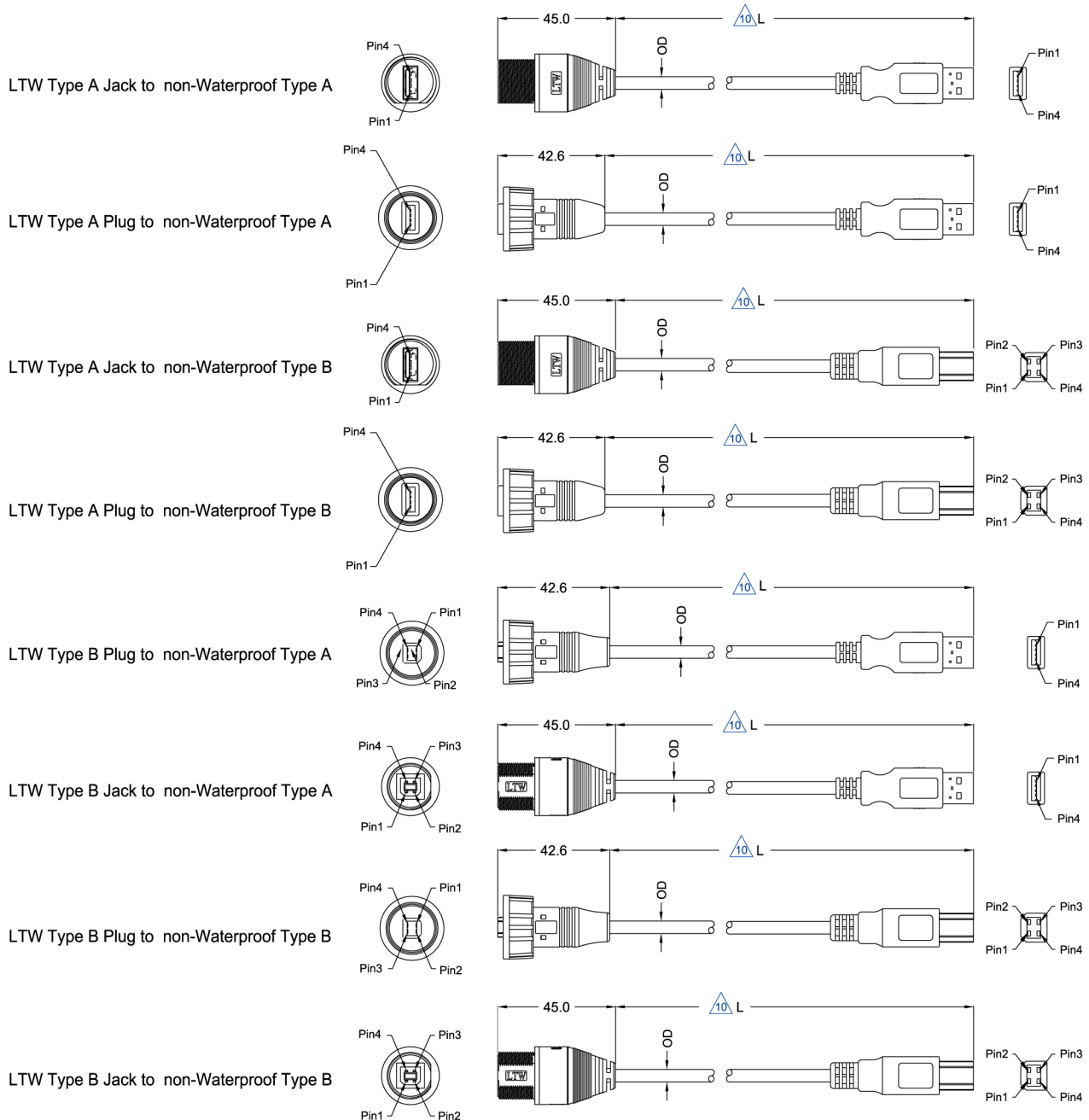

USB