

**NMEA 2000 Connector**



CATALOGUE

# NMEA 2000 Connector

## Range Overview

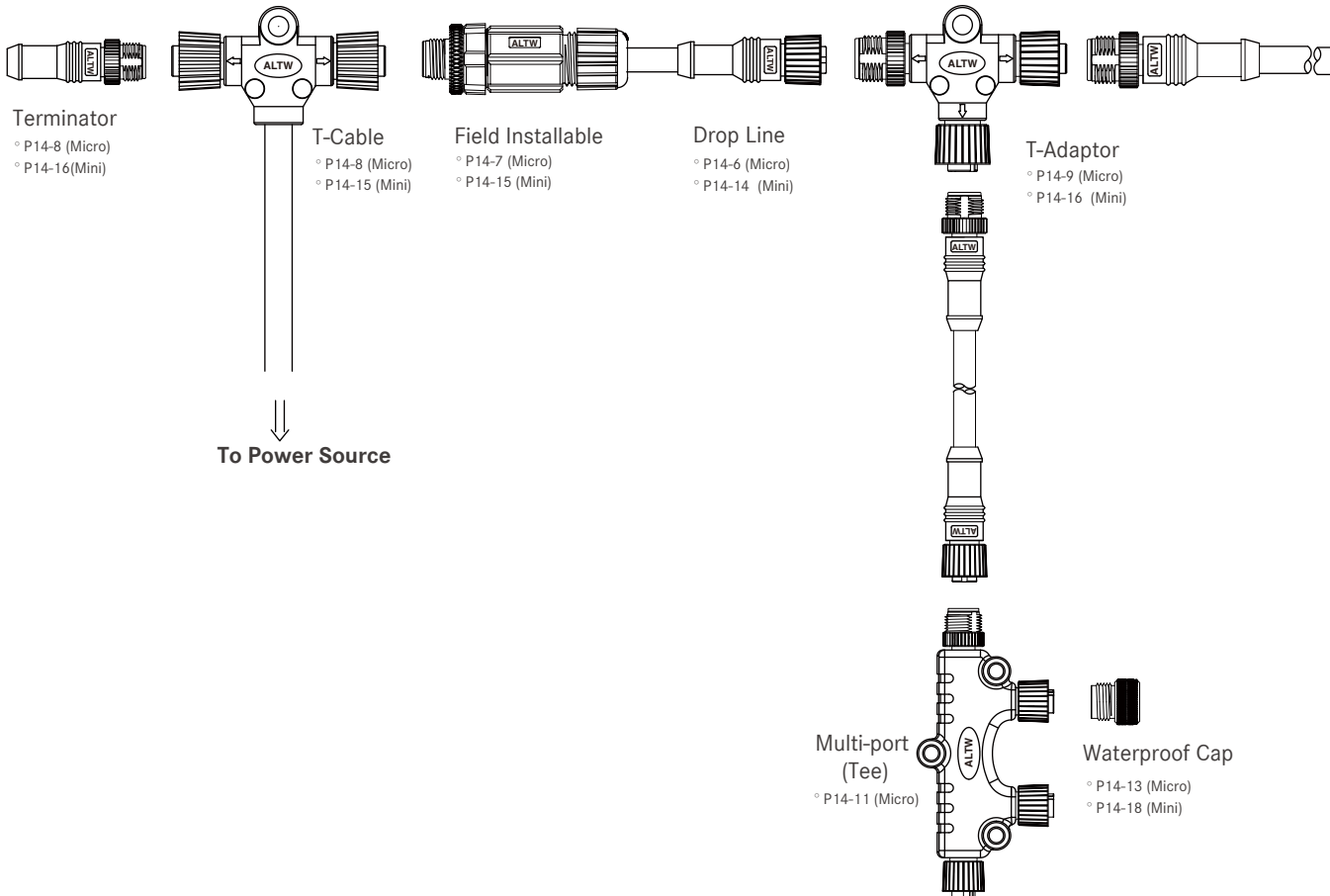

### About NMEA 2000

Amphenol LTW Technology expands its coverage targeting the marine industry that features the NMEA 2000 standard.

The NMEA 2000 standard contains the requirements of a serial data communications network to inter-connect marine electronic equipment on

vessels. It is multi-master and self-configuring, and there is no central network controller. Equipment designed to this standard will have the ability to

share data, including commands and status with other compatible equipment over a status with other compatible equipment over a single channel.

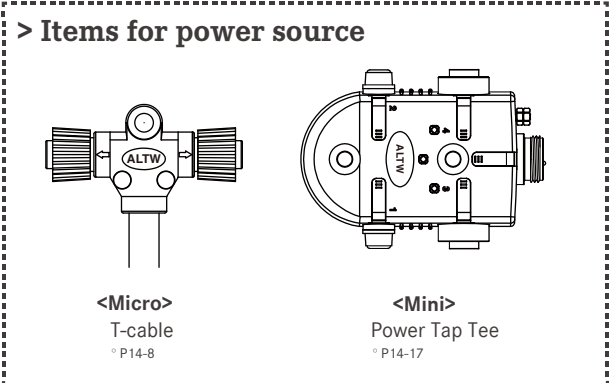
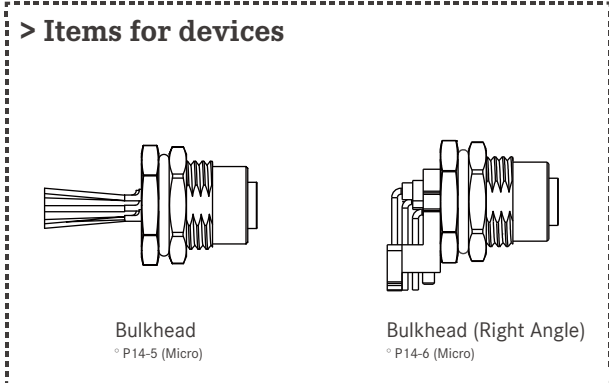
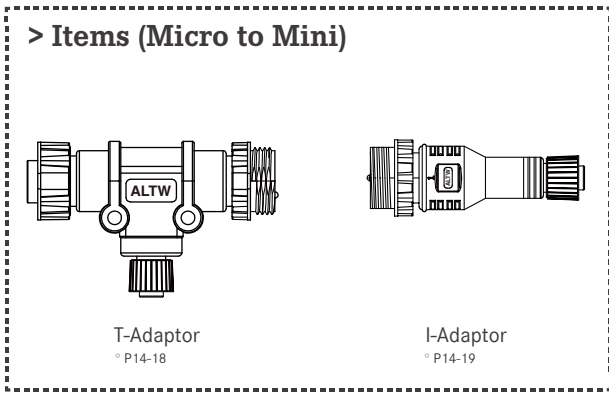
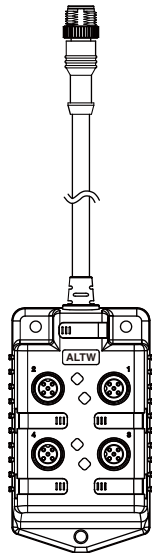
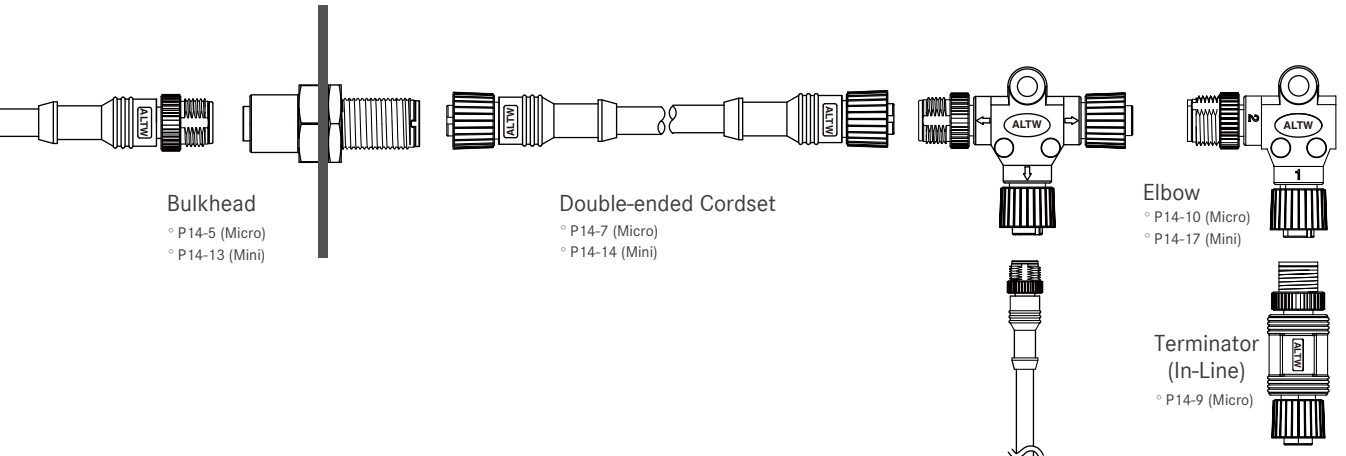

\* Design and specification are subject to change without notice.

# Specification

<b>Identifications</b>	Micro(AWG: 22 AWG, 24 AWG ) Mini(AWG: 18 AWG, 15 AWG )
<b>Description</b>	<p><b>Micro:</b>          Bulkhead (With Wire / Double-ended / Right Angle)          Cable (Drop Line / Double-ended Cordset / Field Installable / T-Cable)          Network Terminator (Single-ended / In-line)          Adaptor (T-Adaptor / Elbow)          Multi-port          Waterproof Cap</p> <p><b>Mini:</b>          Bulkhead (Double-ended)          Cable (Drop Line / Double-ended Cordset / Field Installable / T-Cable)          Network Terminator (Single-ended)          Adaptor (T-Adaptor / Elbow)          Power Tap Tee          Waterproof Cap</p> <p><b>Mini to Micro:</b>          Adaptor (T-Adaptor / I-Adaptor)</p>
<b>Current Rating / Data</b>	4A, 8A
<b>Material</b>	Contacts: Copper Alloy, Gold Plated Contacts Holder: PA
<b>Waterproof Rating</b>	IP67~68
<b>Temperature Range</b>	Receptacle: -40°C~85°C Overmolded with Cable: -20°C~80°C Field Installable: Nylon+GF: -40°C~105°C PU: -20°C~85°C * Higer working temperature upon request.

# Contact Configuration

	Micro-C	Mini-C
	4A	8A
	FF or MM	FF or MM
4Pin		
5Pin		

△ 4A  
○ 8A

---

**Number of Contacts:**  
Ex.2 contacts (02)

---

**Connector (Housing) Gender:**  
Male(M) or Female(F)

---

**Contact Gender:**  
Male(M) or Female(F)

**More to Choose:**

- Solder (S)  
- Solder Cup



- Screw In (B)



# Cabling Information

## Micro

**NMEA Approved**

(A): (24#\* 1P+AL) + (22#\* 1P+AL) + Drain + Mylar + Braid

**Conforming**

(A): (24#\* 1P+AL) + (22#\* 1P+AL) + Drain + AL + Braid

(B): (22#\* 1P+AL) + (18#\* 1P+AL) + Drain + AL + Braid

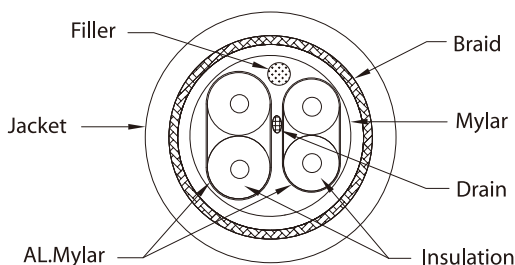

## Mini

**NMEA Approved**

(C): (18#\* 1P+AL) + (15#\* 1P+AL) + Drain + Braid

**Conforming**

(C): (18#\* 1P+AL) + (16#\* 1P+AL) + Drain + AL+Braid

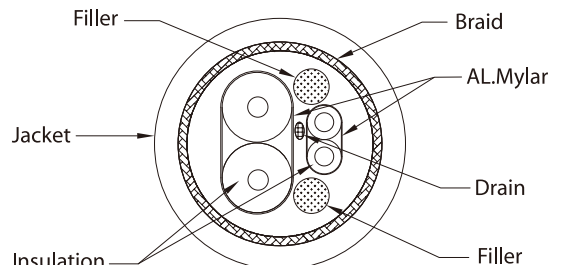

\* Design and specification are subject to change without notice.

# Find Our Standard Products

## Micro > Bulkhead (Double-ended)

<ul style="list-style-type: none"> <li>• 5 Contacts</li> <li>• Screw Thread</li> <li>• Unmated IP68</li> </ul>	<p>18 (Hexagon) For Panel thickness Max 8.5mm</p>	
Type	Connector	Connector 1 (Female Connector / Female Contacts)
	Connector	Connector 2 (Male Connector / Male Contacts)
None- Certified NMEA 2000 (4A, 60V)	MC-000505-0FM-BS001	
Certified NMEA 2000 (4A, 60V)	UMC-000505-0FM-BS001	

## Micro > Bulkhead

<ul style="list-style-type: none"> <li>• 5 Contacts</li> <li>• Screw Thread</li> <li>• For device side</li> <li>• Unmated IP68</li> </ul>	<div style="display: flex; justify-content: space-around;"> <div style="text-align: center;"> <p>* Front Fastened</p> </div> <div style="text-align: center;"> <p>* Rear Fastened</p> </div> </div>	
Type	Connector (Male Connector / Male Contacts)	Connector (Female Connector / Female Contacts)
	None- Certified NMEA 2000 (4A, 60V)	MC-05PMMS-SF8001 MC-05PMMS-SH8001

Micro > Bulkhead (Right Angle)

<ul style="list-style-type: none"> <li>• 5 Contacts</li> <li>• Screw Thread</li> <li>• For device side</li> <li>• Unmated IP68 / Mated IP67</li> </ul>	<p>* IP 68 (Unmated)</p>		<p>* IP 67 (Mated)</p>	
	<p>Connector Type</p>	<p>Connector (Male Connector / Male Contacts)</p>	<p>Connector (Female Connector / Female Contacts)</p>	
<p>None- Certified NMEA 2000 (4A, 60V)</p>	<p>12-05PMMR-SF7001 12-05PMMR-SF8001</p>	<p>12-05PFFR-SF7001 12-05PFFR-SF8001</p>		
<p>None- Certified NMEA 2000 (Plastic / 4A, 60V)</p>	<p>12P-05PMMR-SF8001</p>	<p>12P-05PFFR-SF8001</p>		

Micro > Cable > Drop Line

<ul style="list-style-type: none"> <li>• 5 Contacts</li> <li>• Screw Thread</li> <li>• For power tap connection</li> <li>• Mated IP68</li> </ul>			<p><b>10</b> Cabling Information NMEA Approved (A): (24#*1P+AL) + (22#*1P+AL) + Drain + Mylar + Braid Conforming (A): (24#*1P+AL) + (22#*1P+AL) + Drain + AL + Braid (B): (22#*1P+AL) + (18#*1P+AL) + Drain + AL + Braid **Available in 1, 2, 5, 10 M.</p>
	<p>Connector Type</p>	<p>Connector (Male Connector / Male Contacts)</p>	<p>Connector (Female Connector / Female Contacts)</p>
<p>None- Certified NMEA 2000 (4A, 60V)</p>	<p>MC-05BMMM-SL8 <b>10</b> **</p>	<p>MC-05BFFM-SL8 <b>10</b> **</p>	
<p>None- Certified NMEA 2000 (Plastic / 4A, 60V)</p>	<p>MCP-05BMMM-SL8 <b>10</b> **</p>	<p>MCP-05BFFM-SL8 <b>10</b> **</p>	
<p>Certified NMEA 2000 (4A, 60V)</p>	<p>UMC-05BMMM-SL8 <b>10</b> **</p>	<p>-</p>	

\* Design and specification are subject to change without notice.

Micro > Cable > Double-ended Cordset

<ul style="list-style-type: none"> <li>• 5 Contacts</li> <li>• Screw Thread</li> <li>• Mated IP68</li> </ul>	<p>*Available in 1, 2, 5, 10 M</p>		
	*Cable 22+24+B PVC		
Type \ Connector	Connector 1 (Male Connector Male Contacts)	Connector 1 (Female Connector Female Contacts)	Connector 1 (Male Connector Male Contacts)
	Connector 2 (Male Connector Male Contacts)	Connector 2 (Female Connector Female Contacts)	Connector 2 (Female Connector Female Contacts)
None- Certified NMEA 2000 (4A, 60V)	MC-000505-0MM-CS*	MC-000505-OFF-CS*	MC-000505-0MF-CS*
None- Certified NMEA 2000 (Plastic / (4A, 60V)	PC-000505-0MM-CS*	PC-000505-OFF-CS*	PC-000505-0MF-CS*
Certified NMEA 2000 (4A, 60V)	-	-	UMC-000505-0MF-CSA*

Micro > Cable > Field Installable

<ul style="list-style-type: none"> <li>• 5 Contacts</li> <li>• Screw Thread</li> <li>• Screw-in Contacts</li> <li>• Mated IP68</li> </ul>	<p>* Conforming to NMEA</p> <p>* NMEA approved</p>	
	Connector (Male Connector / Male Contacts)	Connector (Female Connector / Female Contacts)
None- Certified NMEA 2000 (4A, 60V)	12-05BMMB-SL7001 12-05BMMB-SR7001 (Ø4.5 ~Ø6.0mm; 18AWG Max.)	12-05BFFB-SL7001 12-05BFFB-SR7001 (Ø4.5 ~Ø6.0mm; 18AWG Max.)
None- Certified NMEA 2000 (Plastic / 4A, 60V)	12P-05BMMB-SL7001 12P-05BMMB-SR7001 (Ø4.5 ~Ø6.0mm; 18AWG Max.)	12P-05BFFB-SL7001 12P-05BFFB-SR7001 (Ø4.5 ~Ø6.0mm; 18AWG Max.)
Certified NMEA 2000 (4A, 60V)	UMC-05BMMB-SL7001 (Ø4.5 ~Ø7.5mm; 18AWG Max.)	UMC-05BFFB-SL7001 (Ø4.5 ~Ø7.5mm; 18AWG Max.)

Micro > Cable > T-Cable

<ul style="list-style-type: none"> <li>• 5 Contacts</li> <li>• Screw Thread</li> <li>• For Power Tap Connection</li> <li>• Mated IP68</li> </ul>				
	<p>*Cable 22+18+B PVC *Available in 1, 2, 5, 10 M.</p>			
Type	Connector	Connector 1 (Male Connector Male Contacts)	Connector 1 (Female Connector Female Contacts)	Connector 1 (Female Connector Female Contacts)
	Connector 2 (Male Connector Male Contacts)	Connector 2 (Female Connector Female Contacts)	Connector 2 (Male Connector Male Contacts)	
None- Certified NMEA 2000 (4A, 60V)		MC-050500-MM0-TSB*	MC-050500-FF0-TSB*	MC-050500-FM0-TSB*
None- Certified NMEA 2000 (Plastic) (4A, 60V)		PC-050500-MM0-TSB*	PC-050500-FF0-TSB*	PC-050500-FM0-TSB*
Certified NMEA 2000 (4A, 60V)		-	-	UMC-050500-FM0-TSA*

Micro > Network terminator > Terminator

<ul style="list-style-type: none"> <li>• 5 Contacts</li> <li>• Screw Thread</li> <li>• With 120Ω Resistor</li> <li>• Mated IP68</li> </ul>			
	<p>*Design and specification are subject to change without notice.</p>		
Type	Connector	Connector (Male Connector / Male Contacts)	Connector (Female Connector / Female Contacts)
	Connector		
None- Certified NMEA 2000 (4A, 60V)		MC-05BMMT-SL8001	MC-05BFFT-SL8001
None- Certified NMEA 2000 (Plastic / 4A, 60V)		MCP-05BMMT-SL8001	MCP-05BFFT-SL8001
Certified NMEA 2000 (4A, 60V)		UMC-05BMMT-SL8001	UMC-05BFFT-SL8001

\* Design and specification are subject to change without notice.

Micro > Network Terminator > Terminator (In-Line)

<ul style="list-style-type: none"> <li>• 5 Contacts</li> <li>• Screw Thread</li> <li>• With 120Ω Resistor</li> <li>• Mated IP68</li> </ul>		
Type	Connector 1 (Male Connector / Male Contacts)	Connector 1 (Female Connector / Female Contacts)
	Connector 2 (Female Connector / Female Contacts)	Connector 2 (Female Connector / Female Contacts)
None- Certified NMEA 2000 (4A, 60V)	MC-000505-0MF-IS001	* Please contact our sales team for more information

Micro > Adaptor > T-Adaptor

<ul style="list-style-type: none"> <li>• 5 Contacts</li> <li>• Screw Thread</li> <li>• Mated IP68</li> </ul>		
Type	Connector 1 (Female Connector / Female Contacts)	
	Connector 2 (Male Connector / Male Contacts)	
	Connector 3 (Female Connector / Female Contacts)	
None- Certified NMEA 2000 (4A, 60V)	UMC-050505-FMF-TS001	

Micro > Adaptor > Elbow

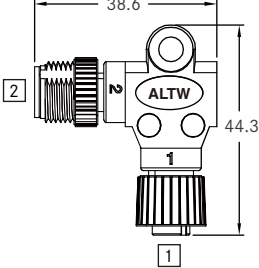
<ul style="list-style-type: none"> <li>• 5 Contacts</li> <li>• Screw Thread</li> <li>• Mated IP68</li> </ul>	
<p>Type</p>	<p>Connector 1 (Female Connector / Female Contacts)</p>
	<p>Connector 2 (Male Connector / Male Contacts)</p>
<p>None- Certified NMEA 2000 (4A, 60V)</p>	<p>MC-000505-0FM-ES001</p>

\* Design and specification are subject to change without notice.

Micro > Adaptor > T-Adaptor

- 5 Contacts
- Screw Thread
- Mated IP68

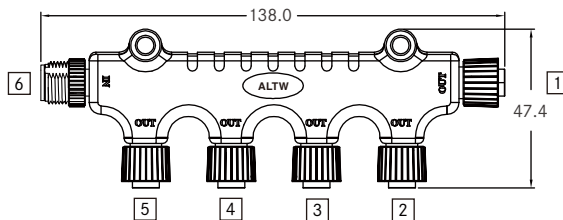

Type	Connector	Connector 1 (Female Connector / Female Contacts)	Connector 1 (Female Connector / Female Contacts)
		Connector 2 (Female Connector / Female Contacts)	Connector 2 (Female Connector / Female Contacts)
		Connector 3 (Female Connector / Female Contacts)	Connector 3 (Female Connector / Female Contacts)
		Connector 4 (Male Connector / Male Contacts)	Connector 4 (Female Connector / Female Contacts)
		-	Connector 5 (Female Connector / Female Contacts)
		-	Connector 6 (Male Connector / Male Contacts)
None- Certified NMEA 2000 (4A, 60V)	S-555500-FFFM00-S001	S-555555-FFFFFM-S001	
Certified NMEA 2000 (4A, 60V)	E-555500-FFFM00-S001	E-555555-FFFFFM-S001	

Micro > Multi-port > Box

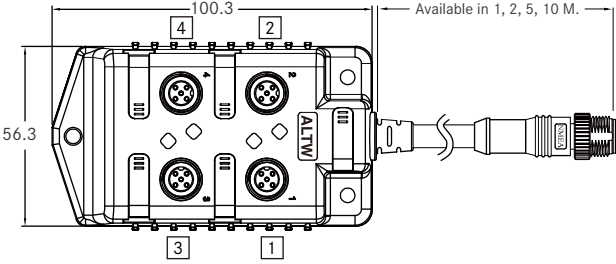
<ul style="list-style-type: none"> <li>• 5 Contacts</li> <li>• Screw Thread</li> <li>• Mated IP68</li> </ul>	 <p>* Cable 22+18+B PVC ** Cable 22+24+B PVC</p>
<p>Type</p> <p>Connector</p>	<p>Connector 1 (Female Connector / Female Contacts)</p>
	<p>Connector 2 (Female Connector / Female Contacts)</p>
	<p>Connector 3 (Female Connector / Female Contacts)</p>
	<p>Connector 4 (Female Connector / Female Contacts)</p>
<p>None- Certified NMEA 2000 (4A, 30V)</p>	<p>S-555500-FFFF00-SB*</p>
<p>Certified NMEA 2000 (4A, 30V)</p>	<p>E-555500-FFFF00-SA**</p>

\* Design and specification are subject to change without notice.

Micro > Cap > Waterproof Cap

<ul style="list-style-type: none"> <li>• Screw Thread</li> <li>• Mated IP68</li> </ul>		<p>* Plastic                      * Metal</p> <p>4 Choose gender of mating pair : Male(M) / Female(F) 7 Choose plastic(1) or metal(2) items</p>	
Size	Mating Pair	Mating Style	Part Number
Micro	Receptacle	Screw Thread	CAP-WBDMSPB2
	Receptacle and Overmolded with Cable	Screw Thread	CAP-WBD 4 SMA 7

Mini > Bulkhead (Double-ended)

<ul style="list-style-type: none"> <li>• 5 Contacts</li> <li>• Screw Thread</li> <li>• Unmated IP68</li> </ul>			
Type	Connector	Connector 1 (Female Connector / Female Contacts)	
		Connector 2 (Male Connector / Male Contacts)	
None- Certified NMEA 2000 (8A, 600V)		MN-000505-0FM-BS001	
Certified NMEA 2000 (8A, 600V)		UMN-000505-0FM-BS001	

Mini > Cable > Drop Line

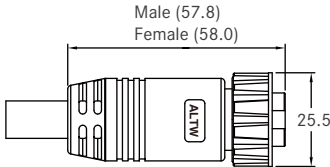
<ul style="list-style-type: none"> <li>• 5 Contacts</li> <li>• Screw Thread</li> <li>• Mated IP68</li> </ul>			<p><b>10</b> Cabling Information                  NMEA Approved                  (C): (18#*1P+AL) + (15#*1P+AL) + Drain + Braid                  Conforming                  (C): (18#*1P+AL) + (16#*1P+AL) + Drain + AL+Braid                  **Available in 1, 2, 5, 10 M.</p>
	Connector Type	Connector (Male Connector / Male Contacts)	Connector (Female Connector / Female Contacts)
	None- Certified NMEA 2000 (8A, 30V)	MN-05AMMM-SL8 <b>10</b> **	MN-05AFFM-SL8 <b>10</b> **
NMEA Approved (8A, 600V)	UMN-05AMMM-SL8 <b>10</b> **	-	

Mini > Cable > Double-ended Cordset

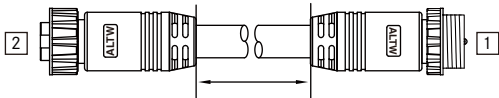
<ul style="list-style-type: none"> <li>• 5 Contacts</li> <li>• Screw Thread</li> <li>• Mated IP68</li> </ul>			<p>*Available in 1, 2, 5, 10 M</p>
	Connector Type	Connector 1 (Male Connector / Male Contacts)	Connector 2 (Female Connector / Female Contacts)
	None- Certified NMEA 2000 (8A, 30V)	MN-000505-0MF-CSC*	
Certified NMEA 2000 (8A, 600V)	UMN-000505-0MF-CSC*		

\* Design and specification are subject to change without notice.

Mini > Cable > Field Installable

<ul style="list-style-type: none"> <li>• 5 Contacts</li> <li>• Screw Thread</li> <li>• Screw-in Contacts</li> <li>• Mated IP68</li> </ul>		
	* Conforming to NMEA	* NMEA approved
Connector Type	Connector (Male Connector / Male Contacts)	Connector (Female Connector / Female Contacts)
None- Certified NMEA 2000 (8A, 600V)	MN-05BMMB-SL7001 (Ø8 ~Ø11mm; 15AWG Max.)	MN-05BFFB-SL7001 (Ø8 ~Ø11mm; 15AWG Max.)
Certified NMEA 2000 (8A, 600V)	UMN-05BMMB-SL7001 (Ø8 ~Ø12.2mm; 15AWG Max.)	UMN-05BFFB-SL7001 (Ø8 ~Ø12.2mm; 15AWG Max.)

Mini > Cable > T-Cable

<ul style="list-style-type: none"> <li>• 5 Contacts</li> <li>• Screw Thread</li> <li>• Mated IP68</li> </ul>		
	<p>* Cable: Refer to P14-4 * Available in 1, 2, 5, 10 M.</p>	
Connector Type	Connector 1 (Female Connector / Female Contacts)	
	Connector 2 (Male Connector / Male Contacts)	
None- Certified NMEA 2000 (8A, 30V)	MN-050500-FM0-TSC*	

▾ Mini > Network Terminator > Terminator

<ul style="list-style-type: none"> <li>• 5 Contacts</li> <li>• Screw Thread</li> <li>• With 120Ω Resistor</li> <li>• Mated IP68</li> </ul>	<p>* Conforming to NMEA * Signal function LED</p> <p>* NMEA approved</p>										
<table border="1" style="width: 100%; border-collapse: collapse;"> <tr> <td style="width: 20%; text-align: center;">Connector Type</td> <td style="width: 40%; text-align: center;">Connector 1 (Male Connector / Male Contacts)</td> <td style="width: 40%; text-align: center;">Connector 1 (Female Connector / Female Contacts)</td> </tr> <tr> <td style="background-color: #e0e0e0;">None- Certified NMEA 2000 (8A, 250V)</td> <td style="text-align: center;">MNL-05BMMT-SL8001</td> <td style="text-align: center;">MNL-05BFFT-SL8001</td> </tr> <tr> <td style="background-color: #e0e0e0;">Certified NMEA 2000 (8A, 250V)</td> <td style="text-align: center;">UMN-05AMMT-SL8001</td> <td style="text-align: center;">UMN-05AFFT-SL8001</td> </tr> </table>	Connector Type	Connector 1 (Male Connector / Male Contacts)	Connector 1 (Female Connector / Female Contacts)	None- Certified NMEA 2000 (8A, 250V)	MNL-05BMMT-SL8001	MNL-05BFFT-SL8001	Certified NMEA 2000 (8A, 250V)	UMN-05AMMT-SL8001	UMN-05AFFT-SL8001		
Connector Type	Connector 1 (Male Connector / Male Contacts)	Connector 1 (Female Connector / Female Contacts)									
None- Certified NMEA 2000 (8A, 250V)	MNL-05BMMT-SL8001	MNL-05BFFT-SL8001									
Certified NMEA 2000 (8A, 250V)	UMN-05AMMT-SL8001	UMN-05AFFT-SL8001									

▾ Mini > Adaptor > T-Adaptor

<ul style="list-style-type: none"> <li>• 5 Contacts</li> <li>• Screw Thread</li> <li>• Mated IP68</li> </ul>								
<table border="1" style="width: 100%; border-collapse: collapse;"> <tr> <td style="width: 20%; text-align: center;">Connector Type</td> <td style="width: 80%; text-align: center;">Connector 1 (Female Connector / Female Contacts)</td> </tr> <tr> <td style="background-color: #e0e0e0;"></td> <td style="text-align: center;">Connector 2 (Male Connector / Male Contacts)</td> </tr> <tr> <td style="background-color: #e0e0e0;"></td> <td style="text-align: center;">Connector 3 (Female Connector / Female Contacts)</td> </tr> </table>	Connector Type	Connector 1 (Female Connector / Female Contacts)		Connector 2 (Male Connector / Male Contacts)		Connector 3 (Female Connector / Female Contacts)		
Connector Type	Connector 1 (Female Connector / Female Contacts)							
	Connector 2 (Male Connector / Male Contacts)							
	Connector 3 (Female Connector / Female Contacts)							
None- Certified NMEA 2000 (8A, 300V)	MN-050505-FMF-TS001							
Certified NMEA 2000 (8A, 300V)	UMN-050505-FMF-TS001							

\* Design and specification are subject to change without notice.

Mini > Adaptor > Elbow

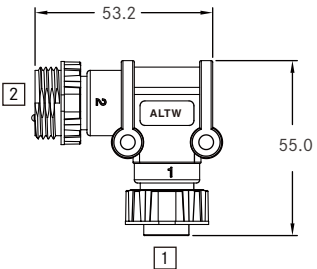
<ul style="list-style-type: none"> <li>• 5 Contacts</li> <li>• Screw Thread</li> <li>• Mated IP68</li> </ul>		
Type	Connector	Connector 1 (Female Connector / Female Contacts)
		Connector 2 (Male Connector / Male Contacts)
None- Certified NMEA 2000 (8A, 300V)	MN-000505-0FM-ES001	

Mini > Power Tap Tee

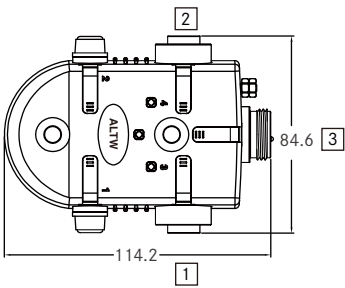
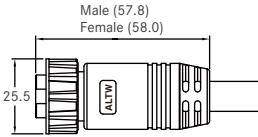
<ul style="list-style-type: none"> <li>• 5 Contacts</li> <li>• Screw Thread</li> <li>• With replaceable fuse</li> <li>• Mated IP68</li> </ul>			<p>* Recommended Mating Pair for <b>3</b></p> <p>MN-04AFFM-SL8D**</p> <p>Male (57.8) Female (58.0)</p>  <p>Cabling Information Conforming (C): (18#*1P+AL) + (16#*1P+AL) + Drain + AL+Braid **Available in 1, 2, 5, 10 M</p>
Type	Connector	Connector 1 (Male Connector / Male Contacts)	
		Connector 2 (Female Connector / Female Contacts)	
		Connector 3 (Female Connector / Female Contacts)	
None- Certified NMEA 2000 (8A, 250V)	N-455000-MFF000-S001		
Certified NMEA 2000 (8A, 250V)	U-455000-MFF000-S001		

Mini > Cap > Waterproof Cap

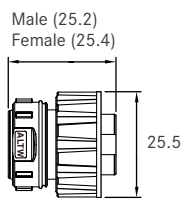
<ul style="list-style-type: none"> <li>• 5 Contacts</li> <li>• Screw Thread</li> <li>• Mated IP68</li> </ul>		 <p>Male (25.2) Female (25.4) 25.5</p>	
		<span style="border: 1px solid black; border-radius: 50%; padding: 2px;">4</span> Choose gender of mating pair: Male(M) / Female(F)	
Size	Mating Pair	Mating Style	P/N
Mini	Receptacle and Overmolded with Cable	Screw Thread	CAP-WMN <span style="border: 1px solid black; border-radius: 50%; padding: 2px;">4</span> SMA1

\* Design and specification are subject to change without notice.

➤ Mini to Micro > Adaptor > T-Adaptor

<ul style="list-style-type: none"> <li>• 5 Contacts</li> <li>• Screw Thread</li> <li>• Mated IP68</li> </ul>	
Type Connector	Connector 1 (Female Connector / Female Contacts)
	Connector 2 (Male Connector / Male Contacts)
	Connector 3 (Female Connector / Female Contacts)
None- Certified NMEA 2000 (4A, 60V)	NC-050505-FMF-TS001
Certified NMEA 2000 (4A, 60V)	UNC-050505-FMF-TS001

➤ Mini to Micro > I-Adaptor

<ul style="list-style-type: none"> <li>• 5 Contacts</li> <li>• Screw Thread</li> <li>• Mated IP68</li> </ul>	
Type Connector	Connector 1 (Male Connector / Male Contacts)
	Connector 2 (Female Connector / Female Contacts)
None- Certified NMEA 2000 (4A, 60V)	NC-000505-0MF-IS001



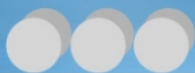

**B.C.E. S.r.l.** - Via Regina Pacis, 54/c - I 41049 Sassuolo (MO), Italy

Tel: (+39) 0536 811616 Fax: (+39) 0536 811500 E-mail: [bce@bce.it](mailto:bce@bce.it) Web: [www.bce.it](http://www.bce.it)

