

NMEA 2000 Connector



CATALOGUE

NMEA 2000 Connector

Range Overview

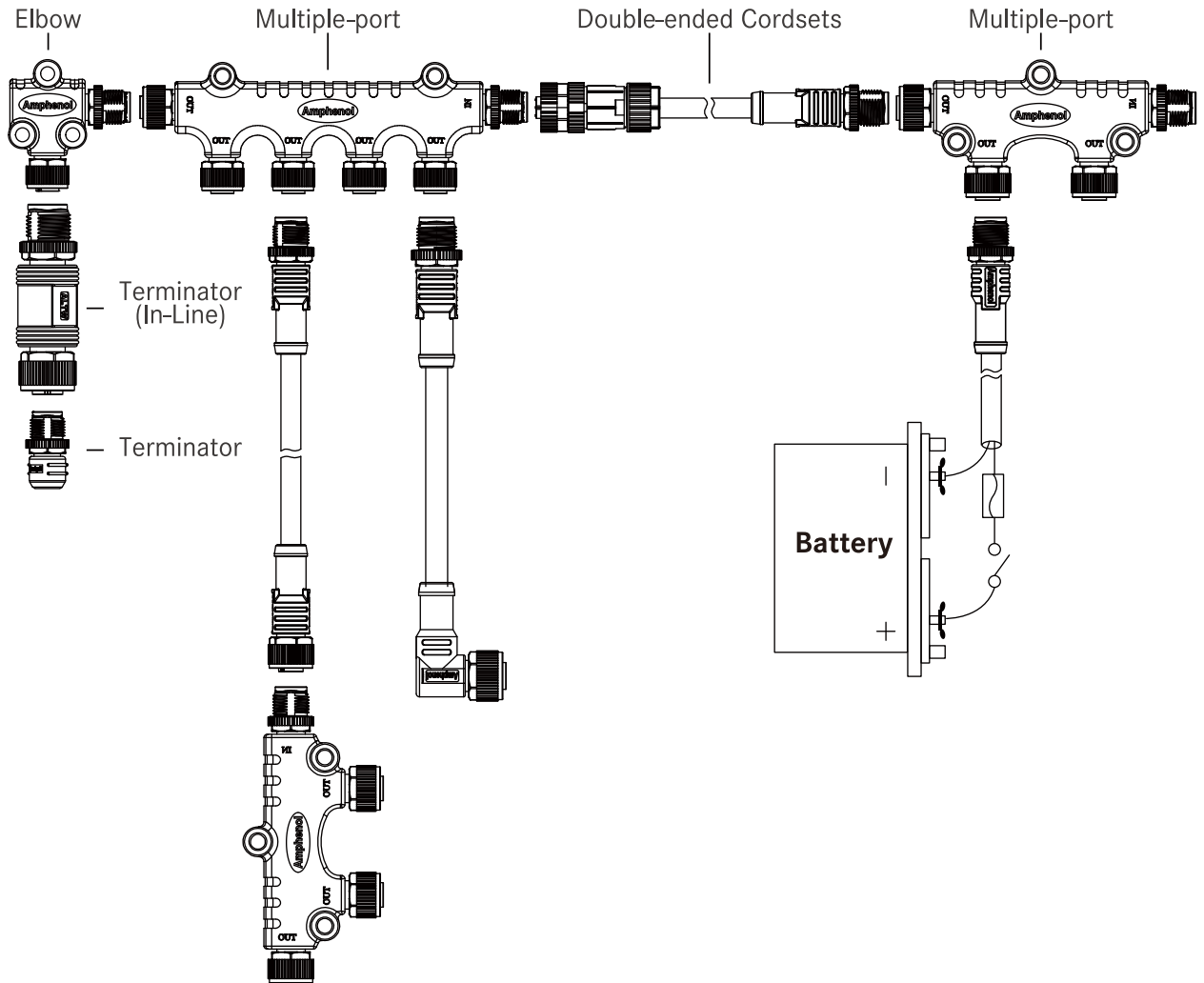

About NMEA 2000

Amphenol LTW Technology expands its coverage targeting the marine industry that features the NMEA 2000 standard.

The NMEA 2000 standard contains the requirements of a serial data communications network to inter-connect marine electronic equipment on

vessels. It is multi-master and self-configuring, and there is no central network controller. Equipment designed to this standard will have the ability to share data, including commands and status with other compatible equipment over a status with other compatible equipment over a single channel.

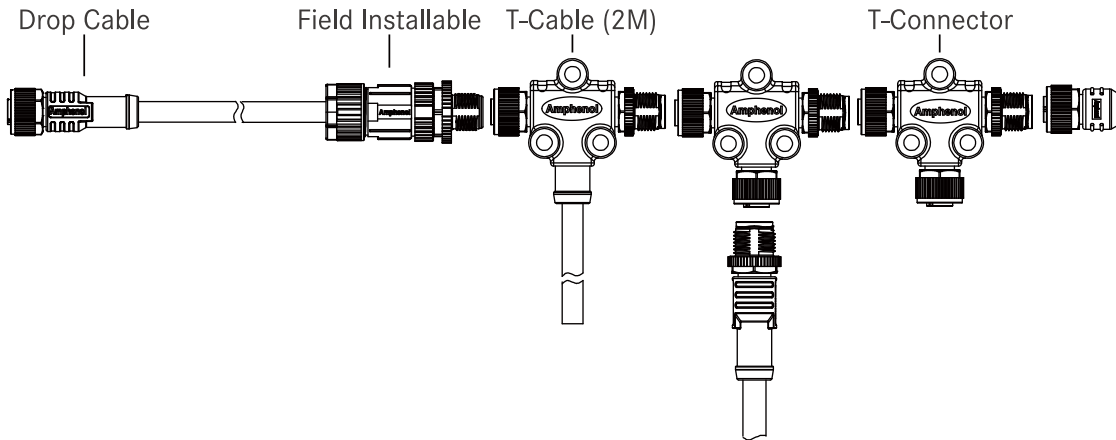

> Items (Mini to Micro)

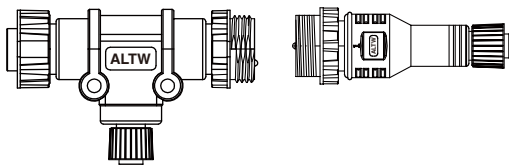

T-Adaptor
° P13-17

I-Adaptor
° P13-17

> Items for devices

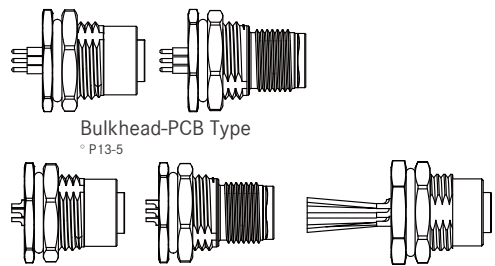

Bulkhead-PCB Type
° P13-5

Bulkhead-Solder Type
° P13-6

> Items for power source

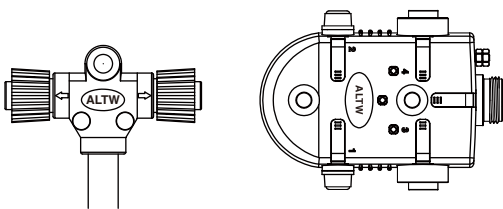

<Micro>
T-cable
° P13-11

<Mini>
Power Tap Tee
° P13-20

> More Selection

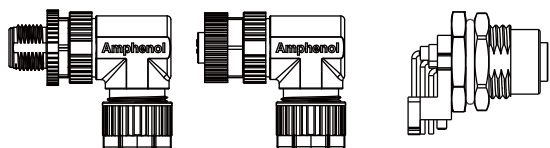

Field Installable
° P13-9

Bulkhead
(Right Angle)
° P13-7

[Note] Design and specification are subject to change without notice.

Specification

Identifications	Micro (AWG: 22 AWG, 24 AWG) Mini (AWG: 18 AWG, 15AWG)
Description	<p>Micro: Bulkhead (With Wire / Double-ended / Right Angle) Cable (Drop Line / Double-ended Cordset / T-Cable) Field Installable Network Terminator (Single-ended / In-line) Adaptor (T-Adaptor / Elbow) Multi-port Waterproof Cap</p> <p>Mini: Bulkhead (Double-ended) Cable (Drop Line / Double-ended Cordset / T-Cable) Field Installable Network Terminator (Single-ended) Adaptor (T-Adaptor / Elbow) Power Tap Tee Waterproof Cap</p> <p>Mini to Micro: Adaptor (T-Adaptor / I-Adaptor)</p>
Current Rating / Data	Micro: 4A Mini: 8A
Material	Contacts: Copper Alloy, Gold Plated Contacts Holder: PA
Waterproof Rating	IP67~68
Temperature Range	<p>Receptacle: -40°C ~ 85°C Overmolded with Cable: -20°C ~ 80°C Field Installable: Nylon+GF: -40°C ~ 105°C PU: -20°C ~ 85°C</p> <p>* Higer working temperature upon request.</p>

Contact Configuration

	Micro-C	Mini-C
	4A	8A
	FF or MM	FF or MM
4Pin		
5Pin		

4A
 8A

Number of Contacts:
e.g. 2 contacts (02)

Connector (Housing) Gender:
Male(M) or Female(F)

Contact Gender:
Male(M) or Female(F)

More to Choose:

- Solder (S)
- Solder Cup

- Screw In (B)

Cabling Information

Micro

NMEA Approved

(A): (24#* 1P+AL) + (22#* 1P+AL) + Drain + Mylar + Braid

(B): (16#* 1P+AL) + (20# * 1P+AL) +D +AL +Braid

Conforming

(A): (24#* 1P+AL) + (22#* 1P+AL) + Drain + AL + Braid

(B): (22#* 1P+AL) + (18#* 1P+AL) + Drain + AL + Braid

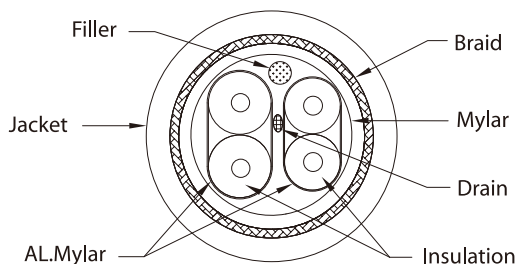

Mini

NMEA Approved

(C): (18#* 1P+AL) + (15#* 1P+AL) + Drain + Braid

Conforming

(C): (18#* 1P+AL) + (16#* 1P+AL) + Drain + AL+Braid

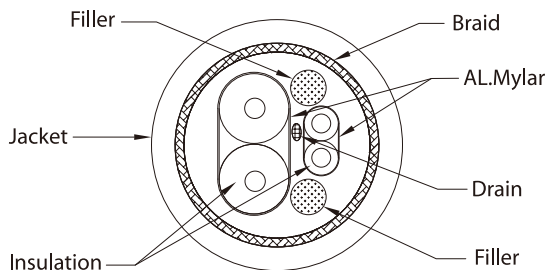

[Note] Design and specification are subject to change without notice.

Find Our Standard Products

Micro > Bulkhead (Double-ended)

<ul style="list-style-type: none"> • 5 Contacts • Screw Thread • Unmated IP68 			
Type	Connector	Part Number (Female Connector / Female Contacts)	
Certified NMEA 2000 (4A, 60V)		UMC-000505-0FM-BS001	
None-Certified NMEA 2000 (4A, 60V)		MC-000505-0FM-BS001	

Micro > Bulkhead (Straight) > PCB Type

<ul style="list-style-type: none"> • 5 Contacts • Screw Thread • For Device Side • PCB Pin (180°) • Unmated IP68 		<p>Metal</p>	<p>Metal</p>
		<p>Plastic</p>	<p>Plastic</p>
Type	Connector	Part Number (Male Connector / Male Contacts)	Part Number (Female Connector / Female Contacts)
Certified NMEA 2000 (4A, 60V)	Metal	HMC-05PMMP-SF8001	HMC-05PFFP-SF8001
	Plastic	HPC-05PMMP-SF8001	HPC-05PFFP-SF8001

∟ Micro > Bulkhead (Straight) > Solder Type

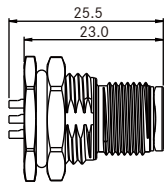
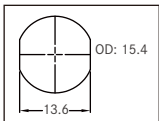
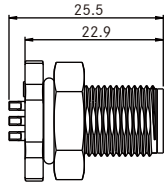
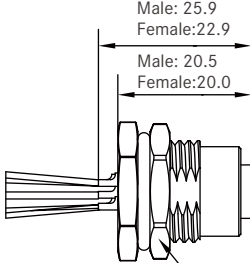
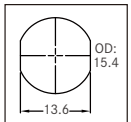
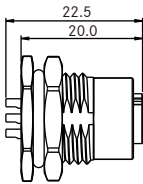
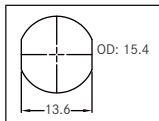
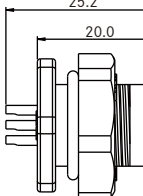
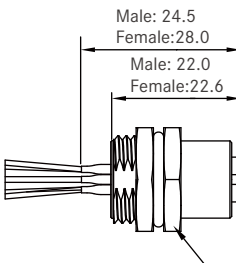
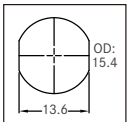
<ul style="list-style-type: none"> • 5 Contacts • Screw Thread • For Device Side • Solder Pin (180°) • Unmated IP68 		<p>Certified</p> <p>Metal</p>  <p>25.5 23.0</p> <p>Maximum Panel Thickness: 4.5mm</p>  <p>OD: 15.4 13.6</p> <p>Plastic</p>  <p>25.5 22.9</p> <p>None-Certified</p>  <p>Male: 25.9 Female: 22.9 Male: 20.5 Female: 20.0</p>  <p>OD: 15.4 13.6</p> <p>18 (Hexagon)</p>		<p>Certified</p> <p>Metal</p>  <p>22.5 20.0</p> <p>Maximum Panel Thickness: 4.5mm</p>  <p>OD: 15.4 13.6</p> <p>Plastic</p>  <p>25.2 20.0</p> <p>None-Certified</p>  <p>Male: 24.5 Female: 28.0 Male: 22.0 Female: 22.6</p>  <p>OD: 15.4 13.6</p> <p>18 (Hexagon)</p> <p>Unit: mm</p>	
		Type	Connector	Part Number (Male Connector / Male Contacts)	Part Number (Female Connector / Female Contacts)
		Certified NMEA 2000 (4A, 60V)	Metal	HMC-05PMMS-SF8001	HMC-05PFFS-SF8001
			Plastic	HPC-05PMMS-SF8001	HPC-05PFFS-SF8001
None-Certified NMEA 2000 (4A, 60V)	Metal	MC-05PMMS-S 8 8001	MC-05PFFS-S 8 8001		

8 Front Fastened (F) or Rear Fastened (H)

[Note] Design and specification are subject to change without notice.

Micro > Bulkhead (Right Angle)

<ul style="list-style-type: none"> • 5 Contacts • Screw Thread • For device side • Unmated IP68 / Mated IP67 		<p>* IP 68 (Unmated)</p> <p>Male (29.5) Female (29.0) Male (20.5) Female (20.0)</p>		<p>* IP 67 (Mated)</p> <p>Male (24.8) Female (25.5) Male (16.2) Female (16.9)</p> <p>Unit: mm</p>												
		<table border="1"> <thead> <tr> <th>Type</th> <th>Connector</th> <th>Part Number (Male Connector / Male Contacts)</th> <th>Part Number (Female Connector / Female Contacts)</th> </tr> </thead> <tbody> <tr> <td rowspan="3">None - Certified NMEA 2000 (4A, 60V)</td> <td rowspan="2">Metal</td> <td>12-05PMMR-SF7001</td> <td>12-05PMMR-SF7001</td> </tr> <tr> <td>12-05PMMR-SF8001</td> <td>12-05PMMR-SF8001</td> </tr> <tr> <td>Plastic</td> <td>12P-05PMMR-SF8001</td> <td>12P-05PMMR-SF8001</td> </tr> </tbody> </table>		Type	Connector	Part Number (Male Connector / Male Contacts)	Part Number (Female Connector / Female Contacts)	None - Certified NMEA 2000 (4A, 60V)	Metal	12-05PMMR-SF7001	12-05PMMR-SF7001	12-05PMMR-SF8001	12-05PMMR-SF8001	Plastic	12P-05PMMR-SF8001	12P-05PMMR-SF8001
Type	Connector	Part Number (Male Connector / Male Contacts)	Part Number (Female Connector / Female Contacts)													
None - Certified NMEA 2000 (4A, 60V)	Metal	12-05PMMR-SF7001	12-05PMMR-SF7001													
		12-05PMMR-SF8001	12-05PMMR-SF8001													
	Plastic	12P-05PMMR-SF8001	12P-05PMMR-SF8001													

Micro > Cable > Drop Line

<ul style="list-style-type: none"> • 5 Contacts • Screw Thread • For Power Tap Connection • Mated IP68 • Current Rating <ul style="list-style-type: none"> - Connector: 4A - Cable: 3A 				<p>Unit: mm</p>																								
		<table border="1"> <thead> <tr> <th>Type</th> <th>Connector</th> <th>Part Number (Male Connector / Male Contacts)</th> <th>Part Number (Female Connector / Female Contacts)</th> </tr> </thead> <tbody> <tr> <td rowspan="2">Certified NMEA 2000 (3A, 60V)</td> <td rowspan="2">Metal</td> <td>HMC-05BMMM-SL8A<u>XX</u>*</td> <td>HMC-05BFFM-SL8A<u>XX</u>*</td> </tr> <tr> <td>UMC-05BMMM-SL8A<u>XX</u>*</td> <td>-</td> </tr> <tr> <td></td> <td>Plastic</td> <td>HPC-05BMMM-SL8A<u>XX</u>*</td> <td>HPC-05BFFM-SL8A<u>XX</u>*</td> </tr> <tr> <td rowspan="4">None - Certified NMEA 2000 (3A, 60V)</td> <td rowspan="2">Metal</td> <td>MC-05BMMM-SL8A<u>XX</u>*</td> <td>MC-05BFFM-SL8A<u>XX</u>*</td> </tr> <tr> <td>MC-05BMMM-SL8B<u>XX</u>*</td> <td>MC-05BFFM-SL8B<u>XX</u>*</td> </tr> <tr> <td rowspan="2">Plastic</td> <td>MCP-05BMMM-SL8A<u>XX</u>*</td> <td>MCP-05BFFM-SL8A<u>XX</u>*</td> </tr> <tr> <td>MCP-05BMMM-SL8B<u>XX</u>*</td> <td>MCP-05BFFM-SL8B<u>XX</u>*</td> </tr> </tbody> </table>		Type	Connector	Part Number (Male Connector / Male Contacts)	Part Number (Female Connector / Female Contacts)	Certified NMEA 2000 (3A, 60V)	Metal	HMC-05BMMM-SL8A <u>XX</u> *	HMC-05BFFM-SL8A <u>XX</u> *	UMC-05BMMM-SL8A <u>XX</u> *	-		Plastic	HPC-05BMMM-SL8A <u>XX</u> *	HPC-05BFFM-SL8A <u>XX</u> *	None - Certified NMEA 2000 (3A, 60V)	Metal	MC-05BMMM-SL8A <u>XX</u> *	MC-05BFFM-SL8A <u>XX</u> *	MC-05BMMM-SL8B <u>XX</u> *	MC-05BFFM-SL8B <u>XX</u> *	Plastic	MCP-05BMMM-SL8A <u>XX</u> *	MCP-05BFFM-SL8A <u>XX</u> *	MCP-05BMMM-SL8B <u>XX</u> *	MCP-05BFFM-SL8B <u>XX</u> *
Type	Connector	Part Number (Male Connector / Male Contacts)	Part Number (Female Connector / Female Contacts)																									
Certified NMEA 2000 (3A, 60V)	Metal	HMC-05BMMM-SL8A <u>XX</u> *	HMC-05BFFM-SL8A <u>XX</u> *																									
		UMC-05BMMM-SL8A <u>XX</u> *	-																									
	Plastic	HPC-05BMMM-SL8A <u>XX</u> *	HPC-05BFFM-SL8A <u>XX</u> *																									
None - Certified NMEA 2000 (3A, 60V)	Metal	MC-05BMMM-SL8A <u>XX</u> *	MC-05BFFM-SL8A <u>XX</u> *																									
		MC-05BMMM-SL8B <u>XX</u> *	MC-05BFFM-SL8B <u>XX</u> *																									
	Plastic	MCP-05BMMM-SL8A <u>XX</u> *	MCP-05BFFM-SL8A <u>XX</u> *																									
		MCP-05BMMM-SL8B <u>XX</u> *	MCP-05BFFM-SL8B <u>XX</u> *																									

*XX: Cable length available in 1M (01), 2M (02), 5M (05), 10M (10).

Micro > Power Cable

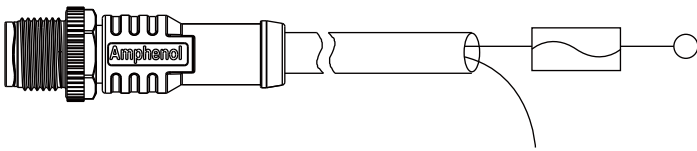
<ul style="list-style-type: none"> • 5 Contacts • Screw Thread • For Powering NMEA 2000 Network System • Mated IP68 • Current Rating <ul style="list-style-type: none"> - Connector: 4A - Cable: 3A (With 3A Fuse) 		Unit: mm						
<table border="1" style="width: 100%; border-collapse: collapse;"> <tr> <td style="width: 20%; text-align: center;">Type</td> <td style="text-align: center;">Connector</td> <td style="text-align: center;">Part Number (Male Connector / Male Contacts)</td> </tr> <tr> <td style="text-align: center;">Certified NMEA 2000 (3A, 60V)</td> <td></td> <td style="text-align: center;">HPC-05CMMM-SL8A<u>XX</u>*</td> </tr> </table>	Type	Connector	Part Number (Male Connector / Male Contacts)	Certified NMEA 2000 (3A, 60V)		HPC-05CMMM-SL8A <u>XX</u> *		
Type	Connector	Part Number (Male Connector / Male Contacts)						
Certified NMEA 2000 (3A, 60V)		HPC-05CMMM-SL8A <u>XX</u> *						

*XX: Cable length available in 1M (01), 2M (02), 5M (05), 10M (10).

Micro > Cable > Double-ended Cordset

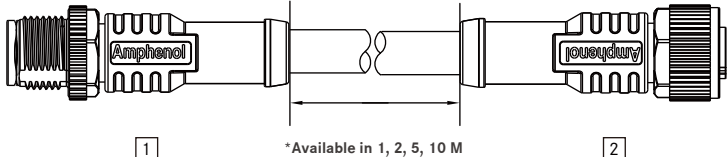
<ul style="list-style-type: none"> • 5 contacts • Screw Thread • For Power Tap Connection • Mated IP68 • Current Rating <ul style="list-style-type: none"> - Connector: 4A - Cable: 3A 																															
		*Available in 1, 2, 5, 10 M																													
		*Cable 22+24+B PVC																													
<table border="1" style="width: 100%; border-collapse: collapse;"> <tr> <td style="width: 20%; text-align: center;">Type</td> <td style="text-align: center;">Connector</td> <td style="text-align: center;">End 1</td> <td style="text-align: center;">End 2</td> <td style="text-align: center;">End 1</td> <td style="text-align: center;">End 2</td> <td style="text-align: center;">End 1</td> <td style="text-align: center;">End 2</td> </tr> <tr> <td></td> <td></td> <td colspan="2" style="text-align: center;">Male</td> <td colspan="2" style="text-align: center;">Female</td> <td colspan="2" style="text-align: center;">Male</td> </tr> <tr> <td></td> <td></td> <td colspan="2"></td> <td colspan="2"></td> <td colspan="2" style="text-align: center;">Female</td> </tr> </table>		Type	Connector	End 1	End 2	End 1	End 2	End 1	End 2			Male		Female		Male								Female							
Type	Connector	End 1	End 2	End 1	End 2	End 1	End 2																								
		Male		Female		Male																									
						Female																									
Certified NMEA 2000 (3A, 60V)	Metal	-		-		HMC-000505-0MF-CSA <u>XX</u> *																									
	Plastic	-		-		UMC-000505-0MF-CS <u>XX</u> *																									
None - Certified NMEA 2000 (3A, 60V)	Metal	MC-000505-0MM-C <u>XX</u> *		MC-000505-0FF-C <u>XX</u> *		MC-000505-0MF-CS <u>XX</u> *																									
	Plastic	PC-000505-0MM-C <u>XX</u> *		PC-000505-0FF-C <u>XX</u> *		PC-000505-0MF-CS <u>XX</u> *																									

*XX: Cable length available in 1 (01), 2 (02), 5 (05), 10 (10)M.

[Note] Design and specification are subject to change without notice.

Micro > Power Cable (Double Ends)

<ul style="list-style-type: none"> • 5 Contacts • Screw Thread • For Powering NMEA 2000 Network System • Mated IP68 • Current Rating <ul style="list-style-type: none"> - Connector: 4A - Cable: 3A 			
Connector Type		End 1	End 2
		Male	Female
Certified NMEA 2000 (3A, 60V)	Plastic	HPC-000505-0MF-DSAXX*	

*XX: Cable length available in 1 (01), 2 (02), 5 (05), 10 (10)M.

Micro > Field Installable (Right Angle)

<ul style="list-style-type: none"> • 5 contacts • Screw Thread • Screw-in Contacts • Mated IP67 				
		Unit: mm		
Type		Connector	Part Number (Male Connector / Male Contacts)	Part Number (Female Connector / Female Contacts)
Certified NMEA 2000 (4A, 60V)	Metal		HMC-05BMMB-SR7001 (Ø4.5 ~Ø6.0mm; 14AWG Max.)	HMC-05BFFB-SR7001 (Ø4.5 ~Ø6.0mm; 14AWG Max.)
	Plastic		HPC-05BMMB-SR7001 (Ø4.5 ~Ø6.0mm; 14AWG Max.)	HPC-05BFFB-SR7001 (Ø4.5 ~Ø6.0mm; 14AWG Max.)
None - Certified NMEA 2000 (4A, 60V)	Metal		12-05BMMB-SR7001 (Ø4.5 ~Ø6.0mm; 18AWG Max.)	12-05BFFB-SR7001 (Ø4.5 ~Ø6.0mm; 18AWG Max.)
	Plastic		12P-05BMMB-SR7001 (Ø4.5 ~Ø6.0mm; 18AWG Max.)	12P-05BFFB-SR7001 (Ø4.5 ~Ø6.0mm; 18AWG Max.)

▾ Micro > Field Installable (Straight)

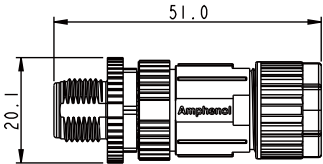
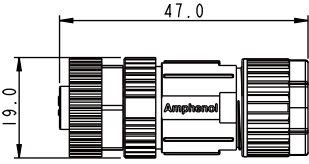
<ul style="list-style-type: none"> • 5 contacts • Screw Thread • Screw-in Contacts • Mated IP67 					
		Unit: mm			
Connector		Part Number (Male Connector / Male Contacts)		Part Number (Female Connector / Female Contacts)	
Type	Material	UMC-05BMMB-SL7001 (Ø4.5 ~ Ø7.5mm; 18AWG Max.)		UMC-05BFFB-SL7001 (Ø4.5 ~ Ø7.5mm; 18AWG Max.)	
		HMC-05BMMB-SL7001 (Ø4.5 ~ Ø6.0mm; 14AWG Max.)		HMC-05BFFB-SL7001 (Ø4.5 ~ Ø6.0mm; 14AWG Max.)	
None - Certified NMEA 2000 (4A, 60V)	Metal	HPC-05BMMB-SL7001 (Ø4.5 ~ Ø6.0mm; 14AWG Max.)		HPC-05BFFB-SL7001 (Ø4.5 ~ Ø6.0mm; 14AWG Max.)	
	Plastic	12-05BMMB-SL7001 (Ø4.5 ~ Ø6.0mm; 18AWG Max.)		12-05BFFB-SL7001 (Ø4.5 ~ Ø6.0mm; 18AWG Max.)	
None - Certified NMEA 2000 (4A, 60V)	Metal	12P-05BMMB-SL7001 (Ø4.5 ~ Ø6.0mm; 18AWG Max.)		12P-05BFFB-SL7001 (Ø4.5 ~ Ø6.0mm; 18AWG Max.)	
	Plastic	12P-05BMMB-SL7001 (Ø4.5 ~ Ø6.0mm; 18AWG Max.)		12P-05BFFB-SL7001 (Ø4.5 ~ Ø6.0mm; 18AWG Max.)	

【Note】 Design and specification are subject to change without notice.

Micro > Cable > T-Cable

<ul style="list-style-type: none"> • 5 contacts • Screw Thread • For Power Tap Connection • Mated IP68 • Current Rating <ul style="list-style-type: none"> - Connector: 4A - Cable: 3A 									
						Unit: mm			
Type		Connector		End 1	End 2	End 1	End 2	End 1	End 2
				Male		Female		Male	Female
Certified NMEA 2000 (3A, 60V)	Metal			-	-			UMC-050500-FM0-TSAXX*	
	Plastic			-	-			HMC-050500-FM0-TSAXX*	
None - Certified NMEA 2000 (3A, 60V)	Metal	MC-050500-MM0-TSBXX*		MC-050500-MM0-TSBXX*	MC-050500-FF0-TSBXX*	MC-050500-FM0-TSBXX*		MC-050500-FM0-TSBXX*	
	Plastic	PC-050500-MM0-TSBXX*		PC-050500-MM0-TSBXX*	PC-050500-FF0-TSBXX*	PC-050500-FM0-TSBXX*		PC-050500-FM0-TSBXX*	

*XX: Cable length available in 1 (01), 2 (02), 5 (05), 10 (10)M.

Micro > Network Terminator > Terminator

<ul style="list-style-type: none"> • 5 contacts • Screw Thread • With 120Ω Resistor • Mated IP68 							
						Unit: mm	
Type		Connector		Part Number (Male Connector / Male Contacts)		Part Number (Female Connector / Female Contacts)	
Certified NMEA 2000 (3A, 60V)	Metal			HMC-05BMMT-SL8001		HMC-05BFFT-SL8001	
	Plastic			HMCP-05BMMT-SL8001		HMCP-05BFFT-SL8001	

Micro > Network Terminator > Terminator

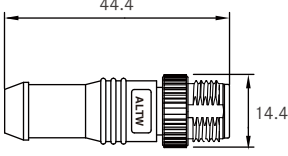
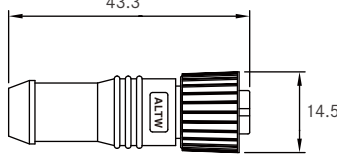
<ul style="list-style-type: none"> • 5 contacts • Screw Thread • With 120Ω Resistor • Mated IP68 							
		Unit: mm					
Type		Connector		Part Number (Male Connector / Male Contacts)		Part Number (Female Connector / Female Contacts)	
Certified NMEA 2000 (3A, 60V)		Metal		UMC-05BMMT-SL8001		UMC-05BFFT-SL8001	
None - Certified NMEA 2000 (3A, 60V)		Metal		MC-05BMMT-SL8001		MC-05BFFT-SL8001	
		Plastic		MCP-05BMMT-SL8001		MCP-05BFFT-SL8001	

Micro > Network Terminator > Terminator (In-Line)

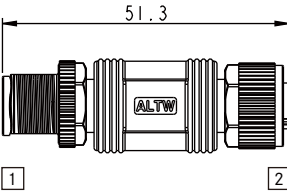
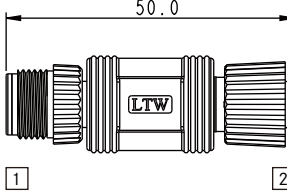
<ul style="list-style-type: none"> • 5 contacts • Screw Thread • With 120Ω Resistor • Mated IP68 							
		Unit: mm					
Type		Connector		End 1	End 2	End 1	End 2
				Male	Female	Male	Female
Certified NMEA 2000 (4A, 60V)		Metal		HMC-000505-0MF-IS001		-	
		Plastic		HPC-000505-0MF-IS001		-	
None - Certified NMEA 2000 (4A, 60V)		Metal		-		MC-000505-0MF-IS001	

[Note] Design and specification are subject to change without notice.

≧ Micro > Adaptor > T-Adaptor

<ul style="list-style-type: none"> • 5 contacts • Screw Thread • Mated IP68 				Unit: mm
Type		Connector		
		End 1 (Female Connector / Female Contacts)		
		End 2 (Male Connector / Male Contacts)		
		End 3 (Female Connector / Female Contacts)		
Certified NMEA 2000 (4A, 60V)	Metal	HMC-050505-FMF-TS001		
	Plastic	UMC-050505-FMF-TS001		
		HPC-050505-FMF-TS001		

≧ Micro > Adaptor > Elbow (L-Adaptor)

<ul style="list-style-type: none"> • 5 contacts • Screw Thread • Mated IP68 				Unit: mm
Type		Connector		
		Part Number (Male Connector / Male Contacts)	Part Number (Female Connector / Female Contacts)	
Certified NMEA 2000 (4A, 60V)	Metal	HMC-000505-0FM-ES001		
	Plastic	HPC-000505-0FM-ES001		
None - Certified NMEA 2000 (4A, 60V)	Metal	MC-000505-0FM-ES001		

Micro > Multi-port T-Adaptor

<ul style="list-style-type: none"> • 5 contacts • Screw Thread • Mated IP68 			
		Unit: mm	
Type	Connector	End 1 (Female Connector / Female Contacts)	End 1 (Female Connector / Female Contacts)
		End 2 (Female Connector / Female Contacts)	End 2 (Female Connector / Female Contacts)
		End 3 (Female Connector / Female Contacts)	End 3 (Female Connector / Female Contacts)
		End 4 (Male Connector / Male Contacts)	End 4 (Female Connector / Female Contacts)
		-	End 5 (Female Connector / Female Contacts)
		-	End 6 (Male Connector / Male Contacts)
Certified NMEA 2000 (4A, 60V)	Metal	E-555500-FFFM00-S001	E-555555-FFFFFM-S001
	Plastic	H-555500-FFFM00-S001	H-555555-FFFFFM-S001
None - Certified NMEA 2000 (4A, 60V)	Metal	P-555500-FFFM00-S001	P-555555-FFFFFM-S001
		S-555500-FFFM00-S001	S-555500-FFFM00-S001

【Note】 Design and specification are subject to change without notice.

Micro > Multi-port > Box

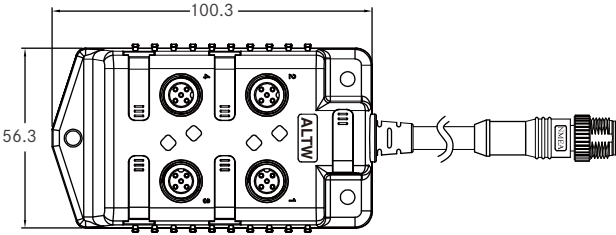
• Unmated IP68			
	Unit: mm		
Type	Part Number		
None - Certified NMEA 2000 (4A, 30V)	S-555500-FFFF00-SBXX*		
Certified NMEA 2000 (4A, 30V)	E-555500-FFFF00-SAXX*		

* XX: Cable length available from 01 ~ 99m

Micro > Waterproof Cap

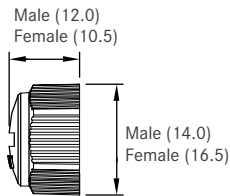
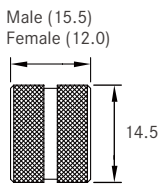
		* Plastic		* Metal	
					
Unit: mm					
Size	Mating Pair	Mating Style	Mating Gender	Part Number	
Micro	Receptacle	Screw Thread	Male	CAP-WBDMSPB2	
	Receptacle and Overmolded with Cable		Male	CAP-WBDMSMA1 (Plastic)	
			Male	CAP-WBDMSMA2 (Metal)	
			Female	CAP-WBDFSMA1 (Plastic)	
			Female	CAP-WBDFSMA2 (Metal)	

Mini > Bulkhead (Double-ended)

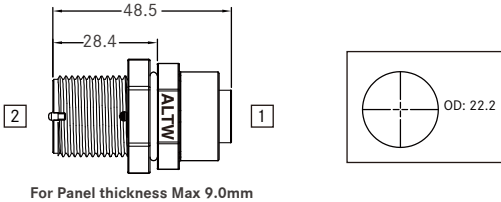
<p>• Unmated IP68</p> 	
<p>Connector Type</p>	<p>Connector 1 (Female Connector / Female Contacts)</p>
	<p>Connector 2 (Male Connector / Male Contacts)</p>
<p>None - Certified NMEA 2000 (8A, 600V)</p>	<p>MN-000505-0FM-BS001</p>
<p>Certified NMEA 2000 (8A, 600V)</p>	<p>UMN-000505-0FM-BS001</p>

Mini > Cable > Drop Line

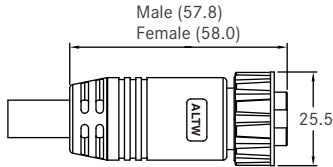
<p>• Mated IP68</p> 		
<p>Type</p>	<p>Part Number (Male Connector / Male Contacts)</p>	<p>Part Number (Female Connector / Female Contacts)</p>
<p>None - Certified NMEA 2000 (8A, 30V)</p>	<p>MN-05AMMM-SL8CXX*</p>	<p>MN-05AFFM-SL8CXX*</p>
<p>Certified NMEA 2000 (8A, 600V)</p>	<p>UMN-05AMMM-SL8CXX*</p>	<p>-</p>

*XX: Cable length available in 1 (01), 2 (02), 5 (05), 10 (10)M.

[Note] Design and specification are subject to change without notice.

Mini > Cable > Double-ended Cordset

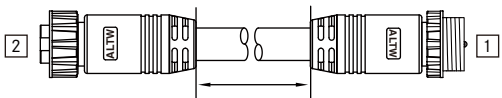
<ul style="list-style-type: none"> • Mated IP68 		 <p>* Available in 1, 2, 5, 10 M</p>	
Connector Type	Connector 1 (Male Connector / Male Contacts)		
	Connector 2 (Female Connector / Female Contacts)		
None - Certified NMEA 2000 (8A, 30V)	MN-000505-0MF-CSCXX*		
Certified NMEA 2000 (8A, 600V)	UMN-000505-0MF-CSCXX*		

*XX: Cable length available in 1 (01), 2 (02), 5 (05), 10 (10)M.

Mini > Field Installable

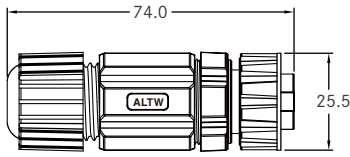
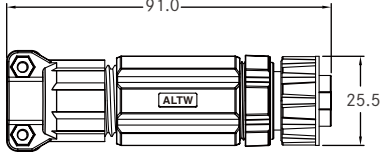
<ul style="list-style-type: none"> • Screw-in Contacts • Mated IP68 		<p>* Conforming to NMEA</p> 	<p>* NMEA approved</p> 
Type	Part Number (Male Connector / Male Contacts)	Part Number (Female Connector / Female Contacts)	
None - Certified NMEA 2000 (8A, 600V)	MN-05BMMB-SL7001	MN-05BFFB-SL7001	
Certified NMEA 2000 (8A, 600V)	UMN-05BMMB-SL7001	UMN-05BFFB-SL7001	

Unit: mm

* Recommended Cable Information:
 - None-Certified: Ø8 ~ Ø11mm; 15AWG Max.
 - Certified NMEA 2000: Ø8 ~ Ø12.2mm; 15AWG Max.

Mini > T-Cable

<ul style="list-style-type: none"> • Mated IP68 		
	Unit: mm	
Connector Type	Connector 1 (Female Connector / Female Contacts)	
	Connector 2 (Male Connector / Male Contacts)	
None - Certified NMEA 2000 (8A, 30V)	MN-050500-FM0-TSCXX*	

*XX: Cable length available in 1 (01), 2 (02), 5 (05), 10 (10)M.

Mini > Network Terminator

<ul style="list-style-type: none"> • With 120Ω Resistor • Mated IP68 	<ul style="list-style-type: none"> * Conforming to NMEA * Signal function LED 		<ul style="list-style-type: none"> * NMEA approved 	
Type	Part Number (Male Connector / Male Contacts)			Part Number (Female Connector / Female Contacts)
None - Certified NMEA 2000 (8A, 250V)	MNL-05BMMT-SL8001			MNL-05BFFT-SL8001
Certified NMEA 2000 (8A, 250V)	UMN-05AMMT-SL8001			UMN-05AFFT-SL8001

[Note] Design and specification are subject to change without notice.

∟ Mini > T-Adaptor

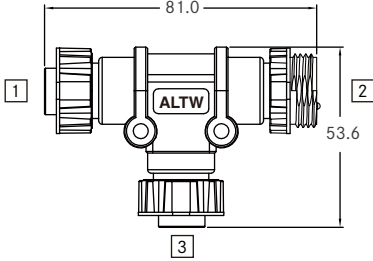
• Mated IP68			
		Unit: mm	
Connector Type	Connector 1 (Female Connector / Female Contacts)		
	Connector 2 (Male Connector / Male Contacts)		
	Connector 3 (Female Connector / Female Contacts)		
None-Certified NMEA 2000 (8A, 300V)	MN-050505-FMF-TS001		
Certified NMEA 2000 (8A, 300V)	UMN-050505-FMF-TS001		

∟ Mini > Adaptor > Elbow (L-Adaptor)

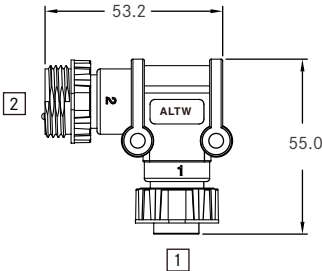
• Mated IP68			
		Unit: mm	
Connector Type	Connector 1 (Female Connector / Female Contacts)		
	Connector 2 (Male Connector / Male Contacts)		
None-Certified NMEA 2000 (8A, 300V)	MN-000505-0FM-ES001		

Mini > Power Tap Tee

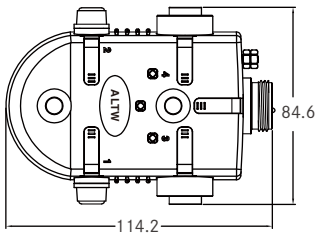
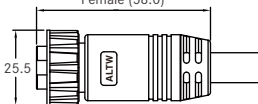
<ul style="list-style-type: none"> • With replaceable fuse • Mated IP68 		<p>Recommended Mating Pair MN-04AFFM-SL8DXX</p> <p>Male (57.8) Female (58.0)</p>  <p>*XX: Cable length available in 1(01), 2(02), 5(05), 10(10)M.</p> <p>Unit: mm</p>
<p>Connector</p> <p>Type</p>	Connector 1 (Male Connector / Male Contacts)	
	Connector 2 (Female Connector / Female Contacts)	
	Connector 3 (Female Connector / Female Contacts)	
None-Certified NMEA 2000 (8A, 250V)	N-455000-MFF000-S001	
Certified NMEA 2000 (8A, 250V)	U-455000-MFF000-S001	

Mini > Waterproof Cap

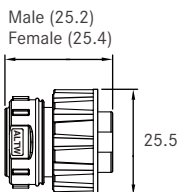
<ul style="list-style-type: none"> • 5 Contacts • Screw Thread • Mated IP68 	 <p>Male (25.2) Female (25.4)</p> <p>25.5</p> <p>Unit: mm</p>			
Size	Mating Pair	Mating Style	Mating Gender	Part Number
Mini	Receptacle and Overmolded with Cable	Screw Thread	Female	CAP-WMNMSMA1
			Male	CAP-WMNFSA1

[Note] Design and specification are subject to change without notice.

↳ Mini to Micro > T-Adaptor

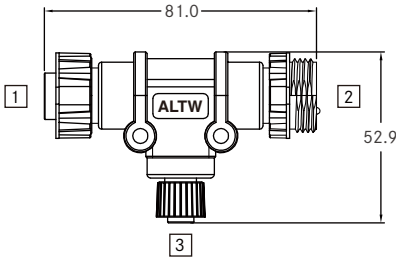
<p>• Mated IP68</p>		 <p style="text-align: right;">Unit: mm</p>	
<p>Connector</p>	<p>Connector 1 (Female Connector / Female Contacts)</p>		
	<p>Connector 2 (Male Connector / Male Contacts)</p>		
	<p>Connector 3 (Female Connector / Female Contacts)</p>		
<p>Type</p>			
<p>None- Certified NMEA 2000 (4A, 60V)</p>	<p>NC-050505-FMF-TS001</p>		
<p>Certified NMEA 2000 (4A, 60V)</p>	<p>UNC-050505-FMF-TS001</p>		

↳ Mini to Micro > I-Adaptor

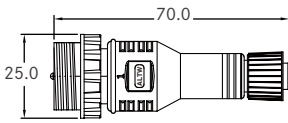
<p>• Mated IP68</p>		 <p style="text-align: right;">Unit: mm</p>	
<p>Type</p>	<p>Part Number</p>		
<p>None- Certified NMEA 2000 (4A, 60V)</p>	<p>NC-000505-0MF-IS001</p>		

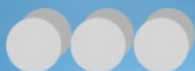

B.C.E. S.r.l. - Via Regina Pacis, 54/c - I 41049 Sassuolo (MO), Italy

Tel: (+39) 0536 811616 Fax: (+39) 0536 811500 E-mail: bce@bce.it Web: www.bce.it

