



CATALOGUE

Sata Connector



Range Overview

∟ Receptacle to Overmolded with Cable

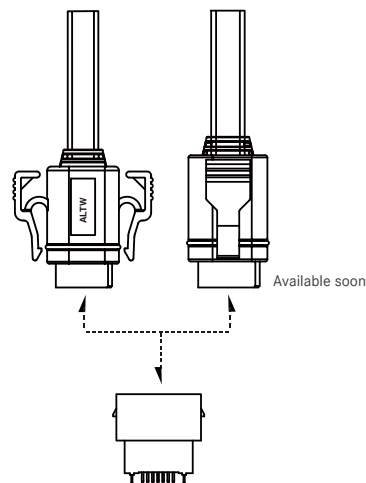

Specification

Identifications	SATA II connector
Description	PCB to Wire
Current Rating	1.5 A
Material	Contacts: Copper Alloy, Gold Plated Connector Body (Housing): LCP / PBT
Waterproof Rating	IP67
Temperature Range	Receptacle: -20°C~80°C Overmolded with Cable: -20°C~80°C
Contact Resistance	≤ 30mΩ
Insulation Resistance	≥ 1000mΩ at DC500V
Durability	500 cycles
More to know	SATA III (upon request)

Ordering Information

1	2	3	4	5	6	7
Specification						
(SA7) SATA 7 Pin Type						
Type						
(2) SATA II * SATA III upon request						
Connector (Housing) Gender						
> For Receptacle / PCB			> For Overmolded with Cable			
(P) Female (Socket)			(A) Male (Plug)			
Connector Body						
> For Receptacle / PCB			> For Overmolded with Cable			
(S) SMD			(L) Cable Latch (Double)			
(D) DIP			(P) Cable Latch (Single)			
Board Lock / Cable Type						
> For Receptacle / PCB			> For Overmolded with Cable			
(TA) Flat Board Lock 2.6mm			(DU) 2 End Cable Type			
(TB) Flat Board Lock 1.6mm			(SN) 1 End Cable Type			
(FA) Harpoon Board Lock 2.6mm						
(FB) Harpoon Board Lock 3.2mm						
Waterproof Rating						
(7) IP 67						
More Information						
> For Receptacle			> For Overmolded with Cable			
(001) Without Cable			(A01) 100MM			
			(A05) 500MM			

* Design and specification are subject to change without notice.

Physical Dimension

Receptacle

DIP Layout

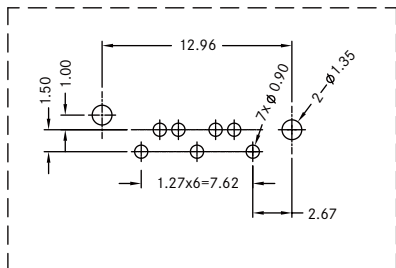

Board Lock Type

Harpoon

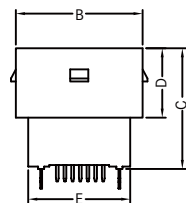
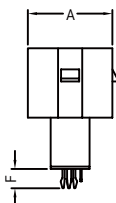

Flate

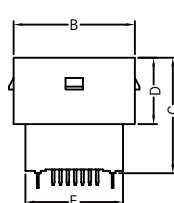
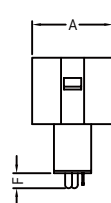

A	B	C	D	E	F
14.0	21.0	20.0	11.5	16.9	2.6
					3.2
14.0	21.0	20.0	11.5	16.9	2.6
					1.6

Receptacle

SMT Layout

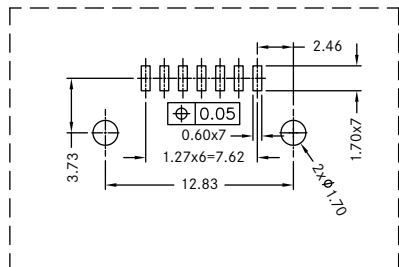

Board Lock Type

Harpoon

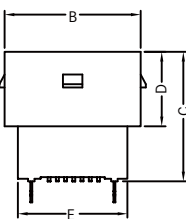
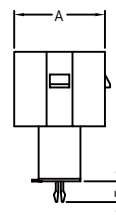

Flate

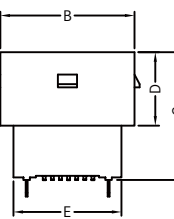
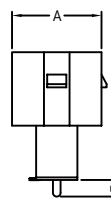

A	B	C	D	E	F
14.0	21.0	20.0	11.5	16.9	2.6
					3.2
14.0	21.0	20.0	11.5	16.9	2.6
					1.6

Overmolded with Cable

Cable Latch (Double)

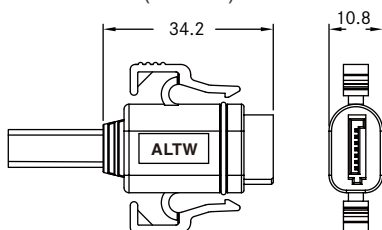

Cable Latch (Single)

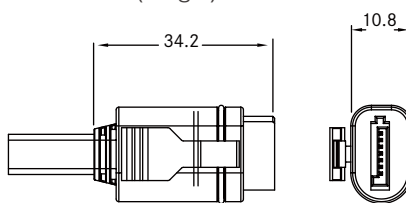

Contact Configuration

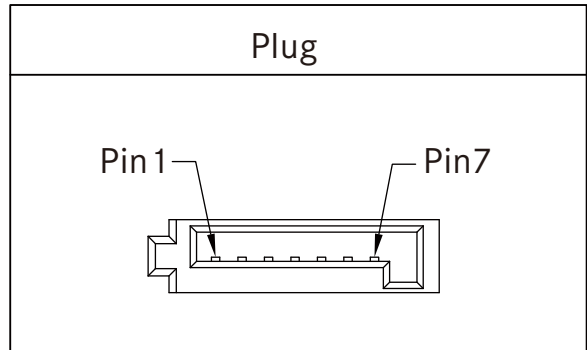
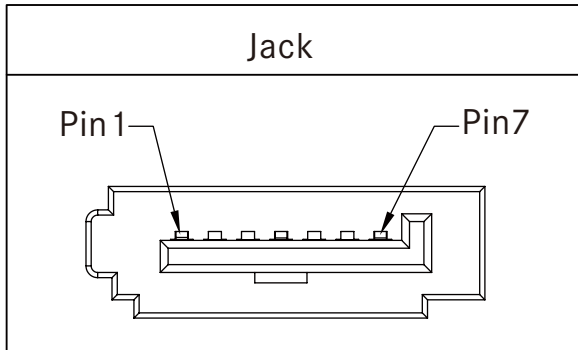

Find Our Standard Products

▾ Receptacle and Mating Pair

	Receptacle> 	Overmolded with Cable
	Jack	Plug
SATA II	SA7-2PDFA-7001 SA7-2PDFB-7001 SA7-2PDTA-7001 SA7-2PDTB-7001 SA7-2PSFA-7001 SA7-2PSFB-7001 SA7-2PSTA-7001 SA7-2PSTB-7001	SA7-2ALDU-7AXX SA7-2APDU-7AXX *Upon request

* Design and specification are subject to change without notice.

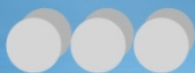

B.C.E. S.r.l. - Via Regina Pacis, 54/c - I 41049 Sassuolo (MO), Italy

Tel: (+39) 0536 811616 Fax: (+39) 0536 811500 E-mail: bce@bce.it Web: www.bce.it

